

车间手推车和泡棉内装插盘

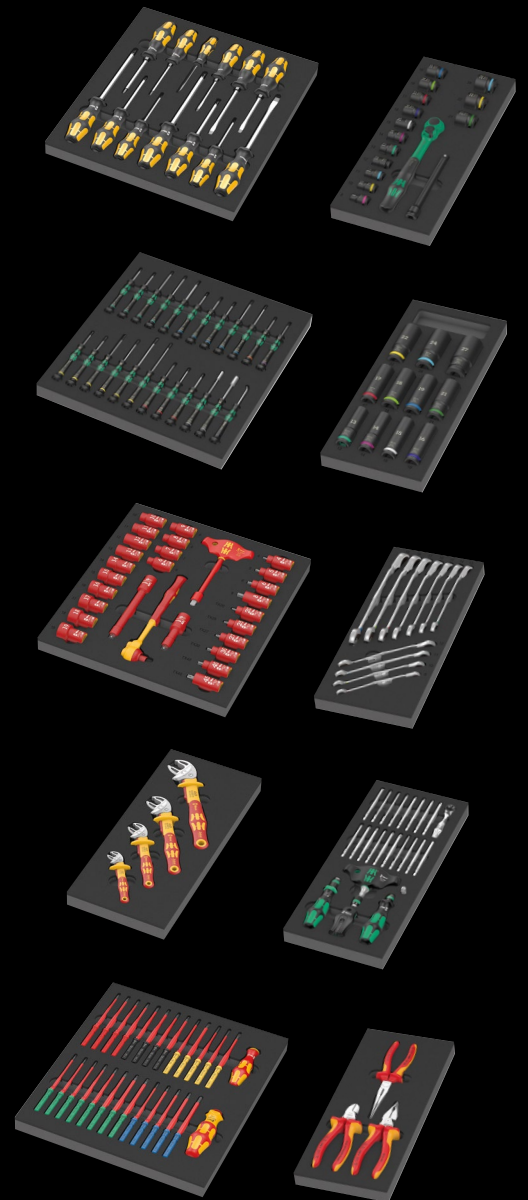

车间手推车配备齐全，车头设计精美，质量上乘。

- **Tool Rebel** 设计中的专用车间手推车
- 由于双面设计，设计极为坚固
- 有 7 个抽屉（5 个平，2 个高），其中 2 个扁平抽屉配备有泡垫和工具
- 扁平抽屉尺寸（宽x高x深）：**522 x 81 x 398 mm**
- 高抽屉尺寸（宽x高x深）：**522 x 166 x 398 mm**
- **100%** 抽屉用滚珠轴承伸缩滑块抽出，自动关闭
- 所有抽屉均经过精心设计，层搭独一无二
- 由于抽屉止位块，倾斜的风险极小——只能打开一个抽屉，不能同时抽出多个抽屉
- 高品质、耐用的泡沫嵌件，不使用化学气体
- 贴合度优化，可从泡垫中以最佳方式移除工具





9700 Tool Rebel 车间手推车 1



Tool Rebel 设计中的专用车间手推车。五个扁平抽屉和两个高抽屉确保工具和材料的高效移动设计。由于双壁构造和全焊结构，设计极为坚固。适用于车间日常高强度工作。配备四块 Wera 泡垫：9710 泡垫螺丝刀组套 1，9720 泡垫 8000 A Zyklop 棘轮组套 1，9731 泡垫 6003 Joker 环形扳手组套 1，9740 泡垫 L 型扳手组套 1。

05150130001 1x 9700 Tool Rebel 车间手推车 1

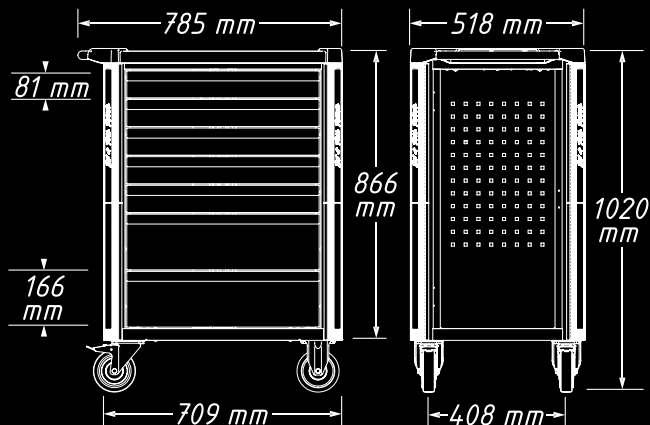

包括以下泡垫

9710



9720

1/4"

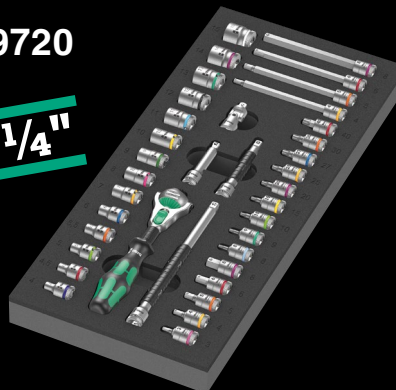

9731



9740



新

9714 泡垫、敲凿用螺丝刀组套 1

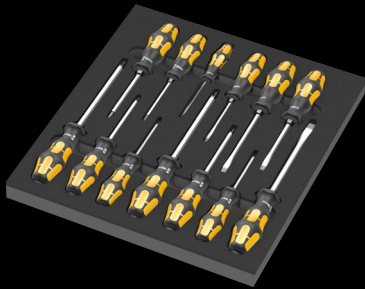

05150105001		
+	917 SPH	1x PH 1x80; 1x PH 2x100; 1x PH 3x150
+	918 SPZ	1x PZ 1x80; 1x PZ 2x100; 1x PZ 3x150
-	932 A	1x 0,6x3,5x80 ¹⁾ ; 1x 0,8x4,5x90; 1x 1,0x5,5x100; 1x 1,2x7,0x125; 1x 1,6x9,0x150
+	977 TORX®	1x TX 20x90; 1x TX 25x100
	9814	1x 344,0x30,0x392,0

¹⁾ 圆形刀杆，不带冲击帽和六角螺栓

新

9715 泡垫 Kraftform 微型螺丝刀组套 1

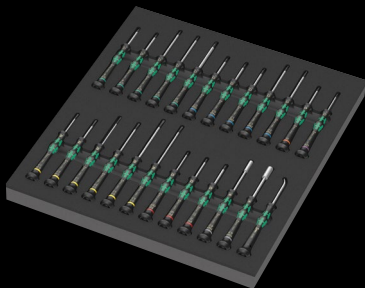

05150106001		
+	2050 Micro	1x PH 000x40 ^{1) 2)} ; 1x PH 00x40 ^{1) 2)} ; 1x PH 0x40 ³⁾
+	2067 TORX® HF	1x TX 5x40; 1x TX 6x40; 1x TX 7x60; 1x TX 8x60; 1x TX 10x60
+	2067 TORX PLUS® IPR Micro	1x 1 IPRx40 ⁴⁾
+	2072 Micro	1x mx40
○	2054 Micro	1x 0,7x40; 1x 0,9x40; 1x 1,3x40; 1x 1,5x60; 1x 2x60
-	2035 Micro	1x 0,23x1,5x40; 1x 0,30x1,8x60; 1x 0,35x2,5x40; 1x 0,40x2,0x60; 1x 0,40x2,5x80; 1x 0,50x3,0x80
●	2069 Micro	1x 4,0x60; 1x 5,5x60
●	1429	1x 1,0x3,5x50
	9815	1x 344,0x30,0x392,0

¹⁾ 专为亚洲的十字PH螺丝优化

²⁾ 刀头的标称长度为10 mm

³⁾ 尺寸根据JIS 0 (日本相机工业标准) 修改

⁴⁾ 无球头

新

9726 泡垫 8007 B VDE Zyklus 3/8" VDE 棘轮组套 1



05150116001		
○	8007 B VDE	1x 3/8"x222,0
○	410 i VDE B	1x 3/8"x130
●	8790 B VDE	1x 6,0x46,0; 1x 7,0x46,0; 1x 8,0x46,0; 1x 9,0x46,0; 1x 10,0x46,0; 1x 11,0x46,0; 1x 12,0x46,0; 1x 13,0x46,0; 1x 14,0x46,0; 1x 15,0x46,0; 1x 16,0x46,0; 1x 17,0x46,0; 1x 18,0x46,0; 1x 19,0x46,0
+	8767 B VDE HF	1x TX 20x55,0; 1x TX 25x55,0; 1x TX 27x55,0; 1x TX 30x55,0; 1x TX 40x55,0; 1x TX 45x59,0
○	8740 B VDE HF	1x 4,0x55,0; 1x 5,0x55,0; 1x 6,0x55,0; 1x 8,0x59,0
○	8794 SB VDE	1x 3/8"x91,0
○	8794 LB VDE	1x 3/8"x166,0
	9826	1x 344,0x30,0x392,0

新

9734 泡垫 6004 Joker VDE 组套 1



05150124001		
	6004 Joker VDE XS	1x 7-10 (1/4"-3/8")x119
	6004 Joker VDE S	1x 10-13 (7/16"-1/2")x155
	6004 Joker VDE M	1x 13-16 (1/2"-5/8")x190
	6004 Joker VDE L	1x 16-19 (5/8"-3/4")x226
	9834	1x 172,0x30,0x392,0

注意：泡垫不适用于旧型号 05501051001 的车间手推车。

新

9751 泡垫 Kraftform Kompakt VDE 组套 1

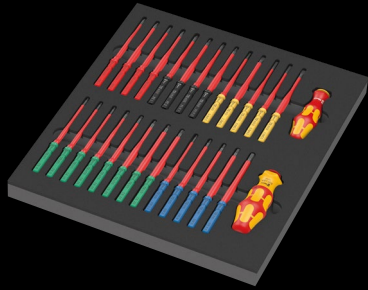

05150151001		
●	837 i RA	1x 9x115
●	817 VDE	1x 9x98
⊕	Kraftform Kompakt VDE 62 iS Take it easy	1x PH 1x157; 1x PH 2x157
⊕	Kraftform Kompakt VDE 65 iS Take it easy	1x PZ 1x157; 1x PZ 2x157
⊕	Kraftform Kompakt VDE 62 iS PH/S Take it easy	1x # 1x157; 1x # 2x157
⊕	Kraftform Kompakt VDE 65 iS PZ/S Take it easy	1x # 1x157; 1x # 2x157
⊕	Kraftform Kompakt VDE 67 i Take it easy	1x TX 8x157; 1x TX 9x157; 1x TX 10x157; 1x TX 27x157; 1x TX 30x157
⊕	Kraftform Kompakt VDE 67 iS Take it easy	1x TX 15x157; 1x TX 20x157; 1x TX 25x157
○	Kraftform Kompakt VDE 64 i Take it easy	1x 2,5x157; 1x 3,0x157; 1x 4,0x157; 1x 5,0x157; 1x 6,0x157
⊖	Kraftform Kompakt VDE 60 iS Take it easy	1x 0,6x3,5x157; 1x 0,8x4,0x157; 1x 1,0x5,5x157
⊖	Kraftform Kompakt VDE 60 i Take it easy	1x 0,4x2,5x157; 1x 1,2x6,5x157
	9851	1x 344,0x30,0x392,0

新

9724 泡垫 8010 B Zyklop 3/8" 舒适型棘轮组套 1



05150114001		
○	8010 B	1x 3/8"x230,0
●	8790 B Impaktor	1x 8,0x30,0; 1x 10,0x30,0; 1x 11,0x30,0; 1x 12,0x30,0; 1x 13,0x30,0; 1x 14,0x30,0; 1x 15,0x30,0; 1x 16,0x30,0; 1x 17,0x30,0; 1x 18,0x30,0; 1x 19,0x30,0; 1x 21,0x32,0; 1x 22,0x32,0; 1x 24,0x32,0
●○	8798 B	1x 3/8"x152,4
	9824	1x 172,0x30,0x392,0

新

9725 泡垫 Zyklop C, 1/2", Impaktor Deep 套筒组套 1

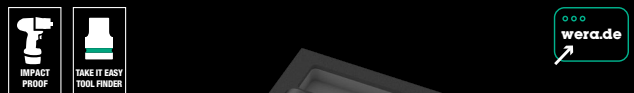

05150115001		
●	8790 C Impaktor Deep	1x 13,0x83,0; 1x 14,0x83,0; 1x 15,0x83,0; 1x 16,0x83,0; 1x 17,0x83,0; 1x 18,0x83,0; 1x 19,0x83,0; 1x 21,0x83,0; 1x 22,0x83,0; 1x 24,0x83,0; 1x 27,0x83,0
	9825	1x 172,0x30,0x392,0

新

9733 泡垫 6001 Joker Switch 组套 1

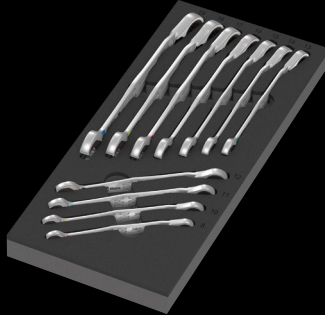

05150123001	
6001 Joker Switch	1x 8x144; 1x 10x159; 1x 11x165; 1x 12x171; 1x 13x179; 1x 14x187; 1x 15x199; 1x 16x213; 1x 17x225; 1x 18x234; 1x 19x246
9833	1x 172,0x30,0x392,0

新

9784 泡垫 KNIPEX 钳组套 VDE 1



05150184001	
	KNIPEX 斜口钳 70 06 160
	KNIPEX 鹬嘴钳, 含刀杆 (鹬嘴钳) 26 16 200
	KNIPEX 鲤鱼钳 08 26 185
9884	1x 172,0x30,0x392,0

新

9752 泡垫 Kraftform Kompakt 棘轮组套 1



1/4"

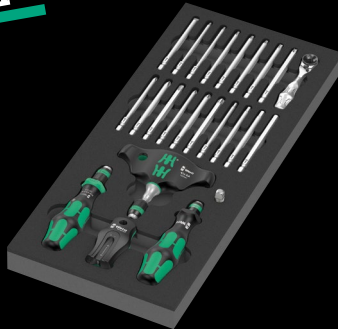

05150152001	
838 RA-R M	1x 1/4"x123,5
416 RA	1x 1/4"x45
816 R	1x 1/4"x119
8001 A	1x 1/4"x87,0
851/4 Z	1x PH 1x89; 1x PH 2x89; 1x PH 3x89 ¹⁾
855/4 Z	1x PZ 1x89; 1x PZ 2x89; 1x PZ 3x89 ¹⁾
867/4 Z TORX®	1x TX 10x89; 1x TX 15x89; 1x TX 20x89; 1x TX 25x89; 1x TX 27x89; 1x TX 30x89; 1x TX 40x89
840/4 Z	1x 3,0x89; 1x 4,0x89; 1x 5,0x89; 1x 6,0x89 ¹⁾
800/4 Z	1x 1,0x5,5x89
870/1	1x 1/4"x25 ²⁾
9500	1x 64,6
9852	1x 172,0x30,0x392,0

¹⁾ 六角形刀片

²⁾ 带摩擦球, 用于手动螺母扳手套筒

9710 泡垫螺丝刀组套 1

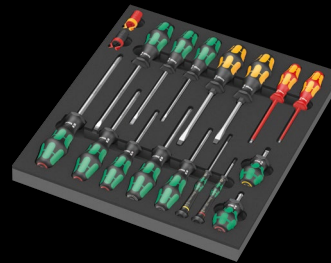

05150101001	
932 A	1x 1,0x5,5x100; 1x 1,2x7,0x125
350 PH	1x PH 1x80; 1x PH 2x100; 1x PH 3x150
350 PH Stubby	1x PH 2x25
355 PZ	1x PZ 1x80; 1x PZ 2x100
335	1x 0,8x4,0x100; 1x 1,0x5,5x125
334	1x 1,2x6,5x150
335 Stubby/迷你螺丝刀	1x 1,0x5,5x24,5
2050 Micro	1x PH 0x40 ¹⁾
2035 Micro	1x 0,40x2,5x80
160 i VDE	1x 0,4x2,5x80 ²⁾ ; 1x 0,6x3,5x100 ²⁾
1441	1x 4,5-6,0x41,0
1442	1x 6,0-8,5x41,0
9810	1x 344,0x30,0x392,0

¹⁾ 尺寸根据JIS 0 (日本相机工业标准) 修改

²⁾ 不带Lasertip激光蚀刻刀头

9711 泡垫 VDE 螺丝刀组套 1

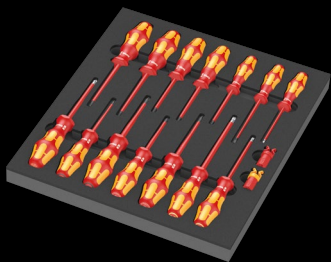

05150102001	
+	162 iS PH VDE 1x PH 1x80; 1x PH 2x100
+	165 iS PZ VDE 1x PZ 1x80; 1x PZ 2x100
+	165 i PZ/S VDE 1x # 2x100
-	160 i VDE 1x 0,4x2,5x80 ¹⁾ ; 1x 0,8x4,0x100; 1x 1,0x5,5x125
-	160 iS VDE 1x 0,6x3,5x100
+	167 i TORX® VDE 1x TX 10x80; 1x TX 15x80; 1x TX 20x80; 1x TX 25x100; 1x TX 30x100
	1440 1x 4,5-6,0x41,0
	1442 1x 6,0-8,5x41,0
	9811 1x 344,0x30,0x392,0

¹⁾ 不带Lasertip激光蚀刻刀头

9713 泡垫六角螺丝刀组套 1

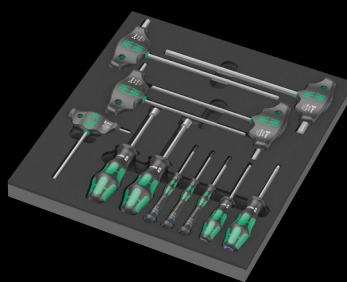

05150104001	
○	354 1x 3,0x75; 1x 4,0x75
○	2054 Micro 1x 1,5x60; 1x 2x60; 1x 2,5x60
○	454 HF 1x 4x100; 1x 5x100; 1x 6x150; 1x 8x200; 1x 10x200
●	395 H0 1x 10,0x90; 1x 13,0x90
	9813 1x 344,0x30,0x392,0

9720 泡垫 8000 A Zyklus 1/4" 棘轮组套 1



9712 泡垫 TORX® HF 螺丝刀组套 1

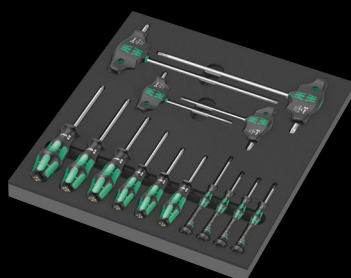

05150103001	
+	367 TORX® HF 1x TX 8x60; 1x TX 9x60; 1x TX 10x80; 1x TX 15x80; 1x TX 20x100; 1x TX 25x100
+	2067 TORX® HF 1x TX 4x40; 1x TX 5x40; 1x TX 6x40; 1x TX 7x60
+	467 TORX® HF 1x TX 20x100; 1x TX 25x100; 1x TX 30x200; 1x TX 40x200
	9812 1x 344,0x30,0x392,0

05150110001	
○	8000 A 1x 1/4"x152,0
●○	8794 LA 1x 1/4"x150,0
●○	8794 SA 1x 1/4"x75,0
●○	8795 A 1x 1/4"x35,5
●○	8794 A 1x 1/4"x56,0
●	8790 HMA 1x 4,0x23,0; 1x 4,5x23,0; 1x 5,0x23,0; 1x 5,5x23,0; 1x 6,0x23,0; 1x 7,0x23,0; 1x 8,0x23,0; 1x 9,0x23,0; 1x 10,0x23,0; 1x 11,0x23,0; 1x 12,0x23,0; 1x 13,0x23,0; 1x 14,0x23,0; 1x 15,0x23,0
+	8767 A HF 1x TX 8x28,0; 1x TX 9x28,0; 1x TX 10x28,0; 1x TX 15x28,0; 1x TX 20x28,0; 1x TX 25x28,0; 1x TX 27x28,0; 1x TX 30x28,0; 1x TX 40x28,0
○	8740 A HF 1x 3,0x28,0; 1x 4,0x28,0; 1x 4,0x100,0; 1x 5,0x28,0; 1x 5,0x100,0; 1x 6,0x28,0; 1x 6,0x100,0; 1x 8,0x28,0; 1x 8,0x100,0
	9820 1x 172,0x30,0x392,0

9721 泡垫 8000 B Zyklop 3/8" 棘轮组套 1



05150111001		
○	8000 B	1x 3/8"x199,0
●○	8794 SB	1x 3/8"x125,0
●○	8794 LB	1x 3/8"x200,0
●○	8795 B	1x 3/8"x50,0
●○	8794 B	1x 3/8"x76,0
●	8790 HMB	1x 6,0x29,0; 1x 7,0x29,0; 1x 8,0x29,0; 1x 9,0x29,0; 1x 10,0x29,0; 1x 11,0x29,0; 1x 12,0x29,0; 1x 13,0x29,0; 1x 14,0x29,0; 1x 15,0x29,0; 1x 16,0x30,0; 1x 17,0x30,0; 1x 18,0x30,0; 1x 19,0x30,0; 1x 20,0x30,0; 1x 21,0x30,0; 1x 22,0x30,0; 1x 24,0x32,0
	9821	1x 172,0x30,0x392,0

9723 泡垫 Zyklop B 3/8" 批头套筒组套 1



05150113001		
●●	8784 B1	1x 1/4"x3/8"x44,0
⊗	8767 B HF	1x TX 15x35,0; 1x TX 20x35,0; 1x TX 25x35,0; 1x TX 25x107,0; 1x TX 27x35,0; 1x TX 27x107,0; 1x TX 30x35,0; 1x TX 30x107,0; 1x TX 40x35,0; 1x TX 40x107,0
○	8740 B HF	1x 4,0x35,0; 1x 4,0x107,0; 1x 5,0x35,0; 1x 5,0x107,0; 1x 6,0x35,0; 1x 6,0x107,0; 1x 7,0x38,5; 1x 8,0x38,5; 1x 8,0x100,0; 1x 10,0x38,5; 1x 10,0x100,0
	9823	1x 172,0x30,0x392,0

9722 泡垫 8000 C Zyklop 1/2" 棘轮组套 1



05150112001		
○	8000 C	1x 1/2"x277,0
●○	8794 LC	1x 1/2"x250,0
●○	8794 SC	1x 1/2"x125,0
●○	8795 C	1x 1/2"x69,0
●○	8794 C	1x 1/2"x52,0
●	8790 HMC	1x 10,0x37,0; 1x 11,0x37,0; 1x 12,0x37,0; 1x 13,0x37,0; 1x 14,0x37,0; 1x 15,0x37,0; 1x 16,0x37,0; 1x 17,0x37,0; 1x 18,0x37,0; 1x 19,0x37,0; 1x 20,0x37,0; 1x 21,0x37,0; 1x 22,0x37,0; 1x 24,0x37,0; 1x 27,0x40,0; 1x 30,0x42,0; 1x 32,0x42,0
○	8740 C HF	1x 4,0x60,0; 1x 4,0x140,0; 1x 5,0x60,0; 1x 5,0x140,0; 1x 6,0x60,0; 1x 6,0x140,0; 1x 7,0x60,0; 1x 8,0x60,0; 1x 10,0x60,0
	9822	1x 344,0x30,0x392,0

9730 泡垫 6000 Joker 组套 1



05150120001		
	6000 Joker	1x 8x144; 1x 10x159; 1x 11x165; 1x 12x170,7; 1x 13x177; 1x 14x188; 1x 15x200; 1x 16x212; 1x 17x224; 1x 18x235; 1x 19x246
	9830	1x 172,0x30,0x392,0

9731 泡垫 6003 Joker 组套 1



05150121001	
6003 Joker	1x 6x105; 1x 7x110; 1x 8x115; 1x 9x120; 1x 10x125; 1x 11x135; 1x 12x148; 1x 13x160; 1x 14x167; 1x 15x174; 1x 16x182; 1x 17x190; 1x 18x210; 1x 19x230,0; 1x 20x230,0; 1x 21x260; 1x 22x260; 1x 24x280
开瓶器	1x 148
9831	1x 344,0x30,0x392,0

9732 泡垫 6004 Joker 组套 1



05150122001	
6004 Joker XS	1x 7-10 (1/4"-3/8")x117
6004 Joker S	1x 10-13 (7/16"-1/2")x154
6004 Joker M	1x 13-16 (1/2"-5/8")x188
6004 Joker L	1x 16-19 (5/8"-3/4")x224
6004 Joker XL	1x 19-24 (3/4"-15/16")x256
9832	1x 172,0x30,0x392,0

9740 泡垫 L 型扳手组套 1

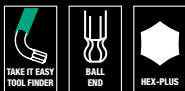

05150140001	
950 SPKL Multicolour	1x 1.5x90; 1x 2.0x101; 1x 2.5x112; 1x 3.0x123; 1x 4.0x137; 1x 5.0x154; 1x 6.0x172; 1x 8.0x195; 1x 10.0x224
967/9 TX XL Multicolour 1	
967 SXL TORX® Multicolour	1x TX 8x90; 1x TX 9x101; 1x TX 10x112
967 SPKXL TORX® Multicolour	1x TX 15x123; 1x TX 20x137; 1x TX 25x154; 1x TX 27x172; 1x TX 30x195; 1x TX 40x224
9500	1x 64,6
STABILA® 袖珍卷尺 BM 100, 3 m, 项目19570	1x 3000,0
9840	1x 172,0x30,0x392,0

9750 泡垫 Kraftform Kompakt 和 Tool-Check PLUS 组套 1



05150150001	
1x Tool-Check PLUS	
● 8001 A	1x 1/4"x87.0
● 813	1x 1/4"x78
● 889/4/1 K	1x 1/4"x50
○ 870/1	1x 1/4"x25 ¹⁾
● 8790 HMA	1x 5.5x23.0; 1x 6.0x23.0; 1x 7.0x23.0; 1x 8.0x23.0; 1x 10.0x23.0; 1x 12.0x23.0; 1x 13.0x23.0
⊕ 851/1 TZ	2x PH 1x25; 3x PH 2x25; 1x PH 3x25
⊕ 855/1 TH	1x PZ 1x25; 3x PZ 2x25; 1x PZ 3x25
⊕ 867/1 TZ TORX®	1x TX 10x25; 1x TX 15x25; 1x TX 20x25; 1x TX 25x25; 1x TX 30x25; 1x TX 40x25
⊕ 867/1 Z TORX® B0	1x TX 10x25; 1x TX 15x25; 1x TX 20x25; 1x TX 25x25; 1x TX 30x25
○ 840/1 Z	1x 3.0x25; 1x 4.0x25; 1x 5.0x25; 1x 6.0x25; 1x 8.0x25
● 800/1 TZ	1x 1.0x5.5x25
1x Kraftform Kompakt 60	
● 816 R	1x 1/4"x119
⊕ 851/4 Z	1x PH 1x89; 1x PH 2x89; 1x PH 3x89 ²⁾
⊕ 855/4 Z	1x PZ 1x89; 1x PZ 2x89; 1x PZ 3x89 ²⁾
⊕ 867/4 Z TORX® B0	1x TX 10x89; 1x TX 15x89; 1x TX 20x89; 1x TX 25x89; 1x TX 30x89
● 800/4 Z	1x 1.0x5.5x89
○ 840/4 Z	1x 3.0x89; 1x 4.0x89; 1x 5.0x89; 1x 6.0x89 ²⁾
魔术贴 70	1x 50.0x70.0
1x 393 S	
●	1x 1/4"x173,5
1x 9850	
	1x 172,0x30,0x392,0

¹⁾ 带摩擦球，用于手动螺母扳手套筒

²⁾ 六角形刀片

9780 泡垫 KNIPEX 钳组套 1



05150180001	
KNIPEX 钢丝 平嘴老虎钳 03 05 180	1x 180
KNIPEX Cobra® 高科 技水泵钳 87 05 250	1x 250
KNIPEX 省力 斜口钳 74 05 160	1x 160
9880	1x 172,0x30,0x392,0

9782 泡垫锤组套 1

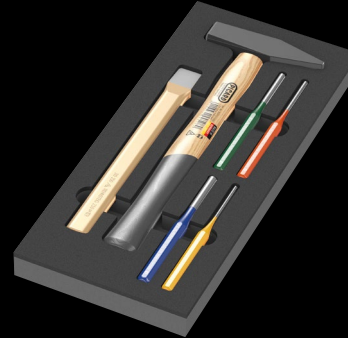

05150182001	
PICARD® 铆 钉锤500g, 0000101-500	1x 500,0
RENNSTEIG 限 量穿孔工具	1x 452 003 6 RC, 3,0x150; 1x 4520046RC, 4,0x150; 1x 4520066RC, 6,0x150; 1x 452 008 6 RC, 8,0x150
RENNSTEIG 平头凿 310 250 1	1x 25,0x13,0x23,0
9882	1x 172,0x30,0x392,0

9781 泡垫 KNIPEX 钳组套 2

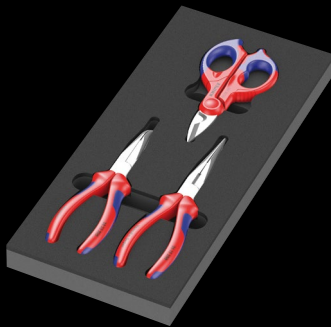

05150181001	
KNIPEX 尖嘴 钳26 15 200	1x 200
KNIPEX 机工 用钳 38 25 200	1x 200
KNIPEX 不锈 钢电工剪 95 05 155	1x 155
9881	1x 172,0x30,0x392,0

9783 泡垫 PFERD 锉刀组套 1

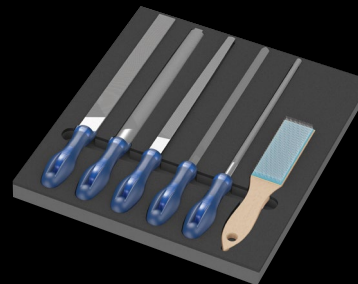

05150183001	
PFERD 机 工用方锉 PF1142 250 H2	1x 250
PFERD 机工 用半圆尖头 锉 1152SP 250 H2	1x 250
PFERD 机工 用圆锉 1162 250 H2	1x 250
PFERD 机工 用手锉 1112 250 H2	1x 250
PFERD 机工 用三角锉 1132 250 H2	1x 250
PFERD 刮刷 HBF 钢丝直 径不小于 0.15	1x 232
9883	1x 344,0x30,0x392,0

敝司将保留可对本目录中所记载和产品特点，种类和执行相关的内容进行更新或修改的权利，事前无需预告。敝司无需对任何因为印刷造成的错误和误导负责。

欢迎联络我们

中国经销代理

凯尼派克工具(上海)有限公司

Phone: +86 (0) 21-58998010
Fax: +86 (0) 21-58998050

E-Mail: info@knipex.com.cn
Internet: www.knipex.com.cn

铭洋工业自动化(上海)有限公司

Phone: +86 (0)21 - 66 24 91 22

E-Mail: service@matfron.com

亚洲总部

Wera Tools Japan G.K.

Phone: +81 70 4813 1142

E-Mail: frank.yang@wera.de

