

Werkstattwagen und Schaumstoffeinlagen

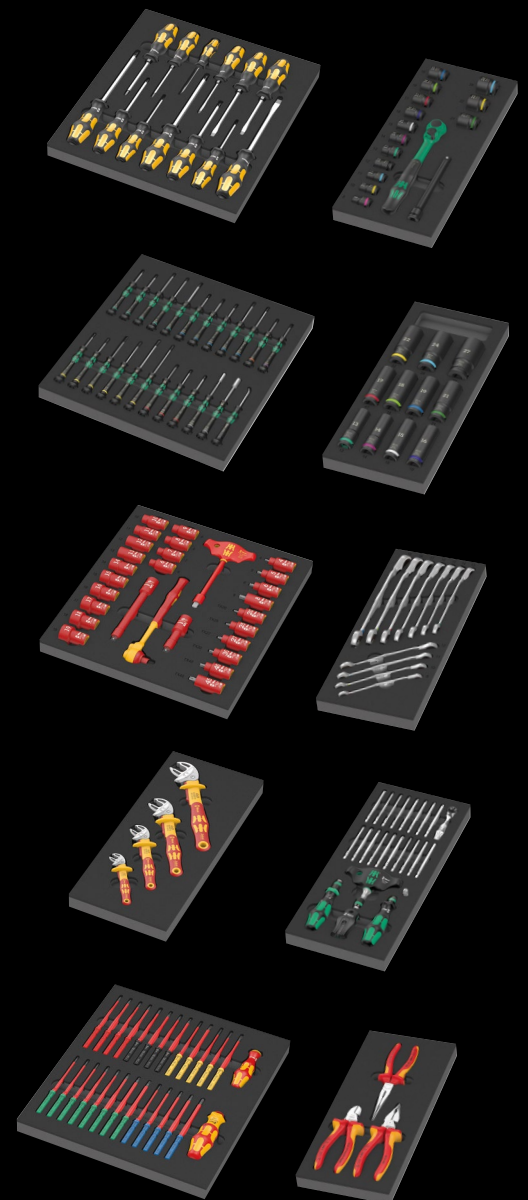

Bestückter Werkstattwagen mit genialem Front-Design in absoluter Spitzenqualität.

- Exklusiver Werkstattwagen im Tool Rebel Design
- Extrem robuste Ausführung durch doppelwandige Konstruktion
- Mit 7 Schubladen (5 flach, 2 hoch) – davon 2 flache Schubladen mit Schaumstoffeinlagen und Werkzeug bestückt
- Maße flache Schubladen (Breite x Höhe x Tiefe): 522 x 81 x 398 mm
- Maße hohe Schubladen (Breite x Höhe x Tiefe): 522 x 166 x 398 mm
- 100 %iger Schubladen-Auszug mit kugelgelagerten Teleskopschienen, Selbsteinzug
- Alle Schubladen sind aufwendig einzeln foliert
- Minimales Kipprisiko durch Auszugssperre – nur eine Schublade kann geöffnet werden, kein gleichzeitiger Auszug mehrerer Schubladen
- Hochwertige, langlebige Schaumstoffeinlagen ohne chemische Ausdünstungen
- Optimale Passung zur bestmöglichen Entnahme der Werkzeuge aus den Schaumstoffeinlagen





9700 Tool Rebel Werkstattwagen 1



Inklusive folgender Schaumstoffeinlagen:

9710



9720

1/4"

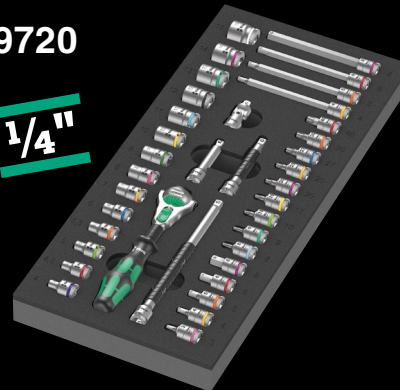

9731



9740



Exklusiver Werkstattwagen-Wagen im Tool Rebel Design. 5 flache und 2 hohe Schubladen sorgen für eine effiziente, mobile Organisation von Werkzeug und Material. Extrem robuste Ausführung durch eine doppelwandige Ausführung und die komplett geschweißte Konstruktion des gesamten Korpus. Für den täglichen harten Werkstatteinsatz. Bestückt mit 4 Wera Schaumstoffeinlagen: 9710 Schaumstoffeinlage Schraubendreher Set 1, 9720 Schaumstoffeinlage 8000 A Zyklus Knarren Set 1, 9731 Schaumstoffeinlage 6003 Joker Ringmaulschlüssel Set 1, 9740 Schaumstoffeinlage Winkelschlüssel Set 1.

05150130001 1x 9700 Tool Rebel Werkstattwagen 1

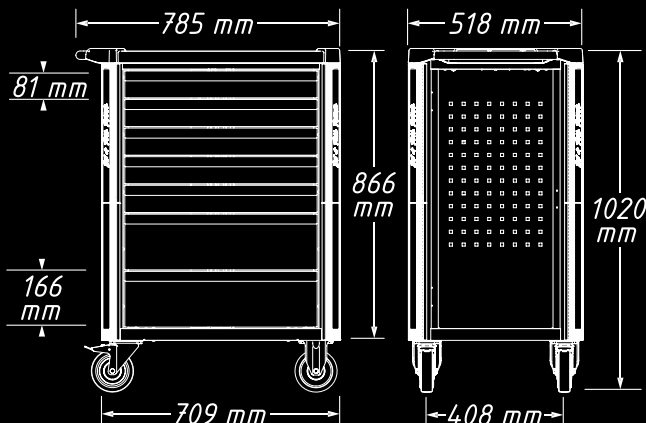

NEU

9714 Schaumstoffeinlage Der Schraubmeißel Schraubendreher Set 1

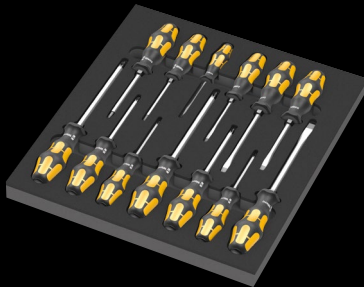

05150105001		
+	917 SPH	1x PH 1x80; 1x PH 2x100; 1x PH 3x150
+	918 SPZ	1x PZ 1x80; 1x PZ 2x100; 1x PZ 3x150
-	932 A	1x 0,6x3,5x80 ¹⁾ ; 1x 0,8x4,5x90; 1x 1,0x5,5x100; 1x 1,2x7,0x125; 1x 1,6x9,0x150
+	977 TORX®	1x TX 20x90; 1x TX 25x100
	9814	1x 344,0x30,0x392,0

¹⁾ Keine durchgehende Klinge, Schlagkappe und Schlüsselhilfe

NEU

9715 Schaumstoffeinlage Schraubendreher Kraftform Micro Set 1

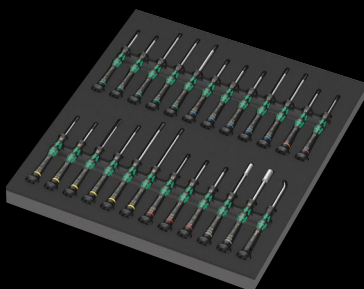

05150106001		
+	2050 Micro	1x PH 000x40 ^{1) 2)} ; 1x PH 00x40 ^{1) 2)} ; 1x PH 0x40 ³⁾
+	2067 TORX® HF	1x TX 5x40; 1x TX 6x40; 1x TX 7x60; 1x TX 8x60; 1x TX 10x60
+	2067 TORX PLUS® IPR Micro	1x 1 IPRx40 ⁴⁾
+	2072 Micro	1x mx40
○	2054 Micro	1x 0,7x40; 1x 0,9x40; 1x 1,3x40; 1x 1,5x60; 1x 2x60
-	2035 Micro	1x 0,23x1,5x40; 1x 0,30x1,8x60; 1x 0,35x2,5x40; 1x 0,40x2,0x60; 1x 0,40x2,5x80; 1x 0,50x3,0x80
●	2069 Micro	1x 4,0x60; 1x 5,5x60
●	1429	1x 1,0x3,5x50
	9815	1x 344,0x30,0x392,0

¹⁾ Optimiert für japanische PH-Schrauben

²⁾ Klinge abtriebsseitig auf einer Länge von 10 mm auf Nennmaß abgedreht

³⁾ Größe 0 entsprechend JCIS 0 (Japanese Camera Industrial Standard) modifiziert

⁴⁾ Ohne Bohrung

NEU

9726 Schaumstoffeinlage 8007 B VDE Zyklop VDE Knarre Set 1, 3/8"

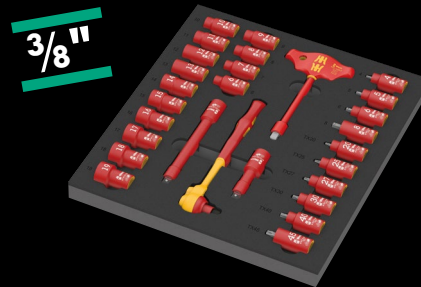

05150116001		
○	8007 B VDE	1x 3/8"x222,0
○	410 i VDE B	1x 3/8"x130
●	8790 B VDE	1x 6,0x46,0; 1x 7,0x46,0; 1x 8,0x46,0; 1x 9,0x46,0; 1x 10,0x46,0; 1x 11,0x46,0; 1x 12,0x46,0; 1x 13,0x46,0; 1x 14,0x46,0; 1x 15,0x46,0; 1x 16,0x46,0; 1x 17,0x46,0; 1x 18,0x46,0; 1x 19,0x46,0
+	8767 B VDE HF	1x TX 20x55,0; 1x TX 25x55,0; 1x TX 27x55,0; 1x TX 30x55,0; 1x TX 40x55,0; 1x TX 45x59,0
○	8740 B VDE HF	1x 4,0x55,0; 1x 5,0x55,0; 1x 6,0x55,0; 1x 8,0x59,0
○	8794 SB VDE	1x 3/8"x91,0
○	8794 LB VDE	1x 3/8"x166,0
	9826	1x 344,0x30,0x392,0

NEU

9734 Schaumstoffeinlage 6004 Joker VDE Set 1



05150124001		
	6004 Joker VDE XS	1x 7-10 (1/4"-3/8")x119
	6004 Joker VDE S	1x 10-13 (7/16"-1/2")x155
	6004 Joker VDE M	1x 13-16 (1/2"-5/8")x190
	6004 Joker VDE L	1x 16-19 (5/8"-3/4")x226
	9834	1x 172,0x30,0x392,0

Achtung: Die Schaumstoffeinlagen passen nicht in das Vorgängermodell Werkstattwagen 05501051001.

NEU

9751 Schaumstoffeinlage Kraftform Kompakt VDE Set 1

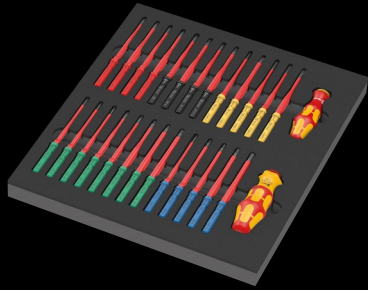

05150151001		
●	837 i RA	1x 9x115
●	817 VDE	1x 9x98
⊕	Kraftform Kompakt VDE 62 iS Take it easy	1x PH 1x157; 1x PH 2x157
⊕	Kraftform Kompakt VDE 65 iS Take it easy	1x PZ 1x157; 1x PZ 2x157
⊕	Kraftform Kompakt VDE 62 iS PH/S Take it easy	1x # 1x157; 1x # 2x157
⊕	Kraftform Kompakt VDE 65 iS PZ/S Take it easy	1x # 1x157; 1x # 2x157
⊕	Kraftform Kompakt VDE 67 i Take it easy	1x TX 8x157; 1x TX 9x157; 1x TX 10x157; 1x TX 27x157; 1x TX 30x157
⊕	Kraftform Kompakt VDE 67 iS Take it easy	1x TX 15x157; 1x TX 20x157; 1x TX 25x157
○	Kraftform Kompakt VDE 64 i Take it easy	1x 2,5x157; 1x 3,0x157; 1x 4,0x157; 1x 5,0x157; 1x 6,0x157
⊖	Kraftform Kompakt VDE 60 iS Take it easy	1x 0,6x3,5x157; 1x 0,8x4,0x157; 1x 1,0x5,5x157
⊖	Kraftform Kompakt VDE 60 i Take it easy	1x 0,4x2,5x157; 1x 1,2x6,5x157
	9851	1x 344,0x30,0x392,0

NEU

9724 Schaumstoffeinlage 8010 B Zyklus Comfort Knarre Set 1, 3/8"



3/8"



05150114001		
○	8010 B	1x 3/8"x230,0
●	8790 B Impaktor	1x 8,0x30,0; 1x 10,0x30,0; 1x 11,0x30,0; 1x 12,0x30,0; 1x 13,0x30,0; 1x 14,0x30,0; 1x 15,0x30,0; 1x 16,0x30,0; 1x 17,0x30,0; 1x 18,0x30,0; 1x 19,0x30,0; 1x 21,0x32,0; 1x 22,0x32,0; 1x 24,0x32,0
●○	8798 B	1x 3/8"x152,4
	9824	1x 172,0x30,0x392,0

NEU

9725 Schaumstoffeinlage Zyklus C, 1/2", Impaktor Deep Steckschlüsseinsatz Set 1

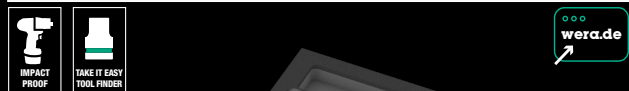

05150115001		
●	8790 C Impaktor Deep	1x 13,0x83,0; 1x 14,0x83,0; 1x 15,0x83,0; 1x 16,0x83,0; 1x 17,0x83,0; 1x 18,0x83,0; 1x 19,0x83,0; 1x 21,0x83,0; 1x 22,0x83,0; 1x 24,0x83,0; 1x 27,0x83,0
	9825	1x 172,0x30,0x392,0

NEU

9733 Schaumstoffeinlage 6001 Joker Switch Set 1

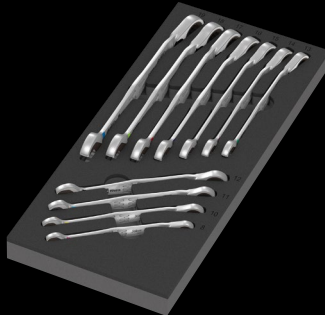

05150123001	
6001 Joker Switch	1x 8x144; 1x 10x159; 1x 11x165; 1x 12x171; 1x 13x179; 1x 14x187; 1x 15x199; 1x 16x213; 1x 17x225; 1x 18x234; 1x 19x246
9833	1x 172,0x30,0x392,0

NEU

9784 Schaumstoffeinlage KNIPEX Zangen Set VDE 1



05150184001	
KNIPEX Seitenschneider 70 06 160	
KNIPEX Flachrundzange mit Schneide (Storchschnabelzange) 26 16 200	
KNIPEX Spitz-Kombizange 08 26 185	
9884	1x 172,0x30,0x392,0

NEU

9752 Schaumstoffeinlage Kraftform Kompakt Ratschen-Set 1



1/4"

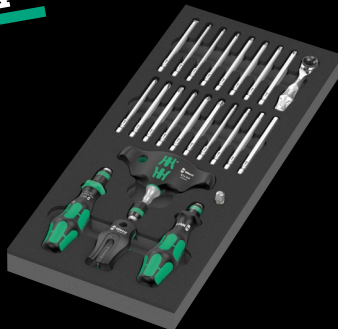

05150152001	
838 RA-R M	1x 1/4"x123,5
416 RA	1x 1/4"x45
816 R	1x 1/4"x119
8001 A	1x 1/4"x87,0
851/4 Z	1x PH 1x89; 1x PH 2x89; 1x PH 3x89 ¹⁾
855/4 Z	1x PZ 1x89; 1x PZ 2x89; 1x PZ 3x89 ¹⁾
867/4 Z TORX®	1x TX 10x89; 1x TX 15x89; 1x TX 20x89; 1x TX 25x89; 1x TX 27x89; 1x TX 30x89; 1x TX 40x89
840/4 Z	1x 3,0x89; 1x 4,0x89; 1x 5,0x89; 1x 6,0x89 ¹⁾
800/4 Z	1x 1,0x5,5x89
870/1	1x 1/4"x25 ²⁾
9500	1x 64,6
9852	1x 172,0x30,0x392,0

¹⁾ Sechskantklinge

²⁾ Mit Kugel; für handbetätigte Steckschlüsseleinsätze

9710 Schaumstoffeinlage Schraubendreher Set 1

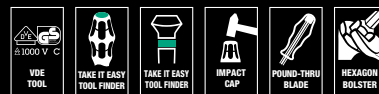

05150101001	
932 A	1x 1,0x5,5x100; 1x 1,2x7,0x125
350 PH	1x PH 1x80; 1x PH 2x100; 1x PH 3x150
350 PH	1x PH 2x25
Stubby/Vergaserschraubendreher	
355 PZ	1x PZ 1x80; 1x PZ 2x100
335	1x 0,8x4,0x100; 1x 1,0x5,5x125
334	1x 1,2x6,5x150
335 Stubby/Vergaserschraubendreher	1x 1,0x5,5x24,5
2050 Micro	1x PH 0x40 ¹⁾
2035 Micro	1x 0,40x2,5x80
160 i VDE	1x 0,4x2,5x80 ²⁾ ; 1x 0,6x3,5x100 ²⁾
1441	1x 4,5-6,0x41,0
1442	1x 6,0-8,5x41,0
9810	1x 344,0x30,0x392,0

¹⁾ Größe 0 entsprechend JICIS 0 (Japanese Camera Industrial Standard) modifiziert

²⁾ kein Lasertip

9711 Schaumstoffeinlage VDE Schraubendreher Set 1

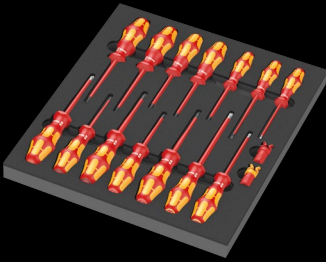

05150102001	
+	162 iS PH VDE 1x PH 1x80; 1x PH 2x100
+	165 iS PZ VDE 1x PZ 1x80; 1x PZ 2x100
+	165 i PZ/S VDE 1x # 2x100
-	160 i VDE 1x 0,4x2,5x80 ¹⁾ ; 1x 0,8x4,0x100; 1x 1,0x5,5x125
-	160 iS VDE 1x 0,6x3,5x100
+	167 i TORX® VDE 1x TX 10x80; 1x TX 15x80; 1x TX 20x80; 1x TX 25x100; 1x TX 30x100
	1440 1x 4,5-6,0x41,0
	1442 1x 6,0-8,5x41,0
	9811 1x 344,0x30,0x392,0

¹⁾ kein Lasertip

9713 Schaumstoffeinlage Hex Schraubendreher Set 1

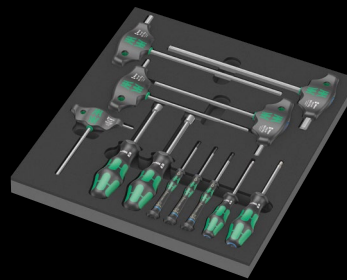

05150104001	
○	354 1x 3,0x75; 1x 4,0x75
○	2054 Micro 1x 1,5x60; 1x 2x60; 1x 2,5x60
○	454 HF 1x 4x100; 1x 5x100; 1x 6x150; 1x 8x200; 1x 10x200
●	395 H0 1x 10,0x90; 1x 13,0x90
	9813 1x 344,0x30,0x392,0

9720 Schaumstoffeinlage 8000 A Zyklus Knarre 1/4" Set 1



9712 Schaumstoffeinlage TORX® HF Schraubendreher Set 1

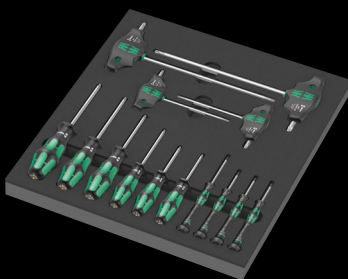
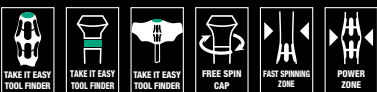

05150103001	
+	367 TORX® HF 1x TX 8x60; 1x TX 9x60; 1x TX 10x80; 1x TX 15x80; 1x TX 20x100; 1x TX 25x100
+	2067 TORX® HF 1x TX 4x40; 1x TX 5x40; 1x TX 6x40; 1x TX 7x60
+	467 TORX® HF 1x TX 20x100; 1x TX 25x100; 1x TX 30x200; 1x TX 40x200
	9812 1x 344,0x30,0x392,0

05150110001	
○	8000 A 1x 1/4"x152,0
●○	8794 LA 1x 1/4"x150,0
●○	8794 SA 1x 1/4"x75,0
●○	8795 A 1x 1/4"x35,5
●○	8794 A 1x 1/4"x56,0
●	8790 HMA 1x 4,0x23,0; 1x 4,5x23,0; 1x 5,0x23,0; 1x 5,5x23,0; 1x 6,0x23,0; 1x 7,0x23,0; 1x 8,0x23,0; 1x 9,0x23,0; 1x 10,0x23,0; 1x 11,0x23,0; 1x 12,0x23,0; 1x 13,0x23,0; 1x 14,0x23,0; 1x 15,0x23,0
+	8767 A HF 1x TX 8x28,0; 1x TX 9x28,0; 1x TX 10x28,0; 1x TX 15x28,0; 1x TX 20x28,0; 1x TX 25x28,0; 1x TX 27x28,0; 1x TX 30x28,0; 1x TX 40x28,0
○	8740 A HF 1x 3,0x28,0; 1x 4,0x28,0; 1x 4,0x100,0; 1x 5,0x28,0; 1x 5,0x100,0; 1x 6,0x28,0; 1x 6,0x100,0; 1x 8,0x28,0; 1x 8,0x100,0
	9820 1x 172,0x30,0x392,0

9721 Schaumstoffeinlage 8000 B Zyklus Knarre 3/8" Set 1



3/8"



05150111001		
○	8000 B	1x 3/8"x199,0
●○	8794 SB	1x 3/8"x125,0
●○	8794 LB	1x 3/8"x200,0
●○	8795 B	1x 3/8"x50,0
●○	8794 B	1x 3/8"x76,0
●	8790 HMB	1x 6,0x29,0; 1x 7,0x29,0; 1x 8,0x29,0; 1x 9,0x29,0; 1x 10,0x29,0; 1x 11,0x29,0; 1x 12,0x29,0; 1x 13,0x29,0; 1x 14,0x29,0; 1x 15,0x29,0; 1x 16,0x30,0; 1x 17,0x30,0; 1x 18,0x30,0; 1x 19,0x30,0; 1x 20,0x30,0; 1x 21,0x30,0; 1x 22,0x30,0; 1x 24,0x32,0
	9821	1x 172,0x30,0x392,0

9723 Schaumstoffeinlage Zyklus B 3/8" Bitnuss Set 1



3/8"



05150113001		
●●	8784 B1	1x 1/4"x3/8"x44,0
⊗	8767 B HF	1x TX 15x35,0; 1x TX 20x35,0; 1x TX 25x35,0; 1x TX 25x107,0; 1x TX 27x35,0; 1x TX 27x107,0; 1x TX 30x35,0; 1x TX 30x107,0; 1x TX 40x35,0; 1x TX 40x107,0
○	8740 B HF	1x 4,0x35,0; 1x 4,0x107,0; 1x 5,0x35,0; 1x 5,0x107,0; 1x 6,0x35,0; 1x 6,0x107,0; 1x 7,0x38,5; 1x 8,0x38,5; 1x 8,0x100,0; 1x 10,0x38,5; 1x 10,0x100,0
	9823	1x 172,0x30,0x392,0

9722 Schaumstoffeinlage 8000 C Zyklus Knarre 1/2" Set 1



1/2"



05150112001		
○	8000 C	1x 1/2"x277,0
●○	8794 LC	1x 1/2"x250,0
●○	8794 SC	1x 1/2"x125,0
●○	8795 C	1x 1/2"x69,0
●○	8794 C	1x 1/2"x52,0
●	8790 HMC	1x 10,0x37,0; 1x 11,0x37,0; 1x 12,0x37,0; 1x 13,0x37,0; 1x 14,0x37,0; 1x 15,0x37,0; 1x 16,0x37,0; 1x 17,0x37,0; 1x 18,0x37,0; 1x 19,0x37,0; 1x 20,0x37,0; 1x 21,0x37,0; 1x 22,0x37,0; 1x 24,0x37,0; 1x 27,0x40,0; 1x 30,0x42,0; 1x 32,0x42,0
○	8740 C HF	1x 4,0x60,0; 1x 4,0x140,0; 1x 5,0x60,0; 1x 5,0x140,0; 1x 6,0x60,0; 1x 6,0x140,0; 1x 7,0x60,0; 1x 8,0x60,0; 1x 10,0x60,0
	9822	1x 344,0x30,0x392,0

9730 Schaumstoffeinlage 6000 Joker Set 1



05150120001		
	6000 Joker	1x 8x144; 1x 10x159; 1x 11x165; 1x 12x170,7; 1x 13x177; 1x 14x188; 1x 15x200; 1x 16x212; 1x 17x224; 1x 18x235; 1x 19x246
	9830	1x 172,0x30,0x392,0

9731 Schaumstoffeinlage 6003 Joker Set 1

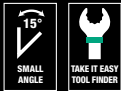

05150121001	
6003 Joker	1x 6x105; 1x 7x110; 1x 8x115; 1x 9x120; 1x 10x125; 1x 11x135; 1x 12x148; 1x 13x160; 1x 14x167; 1x 15x174; 1x 16x182; 1x 17x190; 1x 18x210; 1x 19x230,0; 1x 20x230,0; 1x 21x260; 1x 22x260; 1x 24x280
	Flaschenöffner 1x 148
9831	1x 344,0x30,0x392,0

9732 Schaumstoffeinlage 6004 Joker Set 1



05150122001	
6004 Joker XS	1x 7-10 (1/4"-3/8")x117
6004 Joker S	1x 10-13 (7/16"-1/2")x154
6004 Joker M	1x 13-16 (1/2"-5/8")x188
6004 Joker L	1x 16-19 (5/8"-3/4")x224
6004 Joker XL	1x 19-24x (3/4"-15/16")x256
9832	1x 172,0x30,0x392,0

9740 Schaumstoffeinlage Winkelschlüssel Set 1

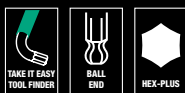

9750 Schaumstoffeinlage Kraftform Kompakt und Tool-Check PLUS Set 1



05150150001	
1x Tool-Check PLUS	
● 8001 A	1x 1/4"x87.0
● 813	1x 1/4"x78
● 889/4/1 K	1x 1/4"x50
○ 870/1	1x 1/4"x25 ¹⁾
● 8790 HMA	1x 5.5x23.0; 1x 6.0x23.0; 1x 7.0x23.0; 1x 8.0x23.0; 1x 10.0x23.0; 1x 12.0x23.0; 1x 13.0x23.0
⊕ 851/1 TZ	2x PH 1x25; 3x PH 2x25; 1x PH 3x25
⊕ 855/1 TH	1x PZ 1x25; 3x PZ 2x25; 1x PZ 3x25
⊕ 867/1 TZ TORX®	1x TX 10x25; 1x TX 15x25; 1x TX 20x25; 1x TX 25x25; 1x TX 30x25; 1x TX 40x25
⊕ 867/1 Z TORX® BO	1x TX 10x25; 1x TX 15x25; 1x TX 20x25; 1x TX 25x25; 1x TX 30x25
○ 840/1 Z	1x 3.0x25; 1x 4.0x25; 1x 5.0x25; 1x 6.0x25; 1x 8.0x25
⊖ 800/1 TZ	1x 1.0x5.5x25
1x Kraftform Kompakt 60	
● 816 R	1x 1/4"x119
⊕ 851/4 Z	1x PH 1x89; 1x PH 2x89; 1x PH 3x89 ²⁾
⊕ 855/4 Z	1x PZ 1x89; 1x PZ 2x89; 1x PZ 3x89 ²⁾
⊕ 867/4 Z TORX® BO	1x TX 10x89; 1x TX 15x89; 1x TX 20x89; 1x TX 25x89; 1x TX 30x89
⊖ 800/4 Z	1x 1.0x5.5x89
○ 840/4 Z	1x 3.0x89; 1x 4.0x89; 1x 5.0x89; 1x 6.0x89 ²⁾
Klettstreifen 70	1x 50.0x70.0
1x 393 S	
●	1x 1/4"x173,5
1x 9850	
	1x 172,0x30,0x392,0

¹⁾ Mit Kugel; für handbetätigte Steckschlüsseleinsätze
²⁾ Sechskantklänge

05150140001	
1x 950/9 Hex-Plus Multicolour 1	
○ 950 SPKL Multicolour	1x 1.5x90; 1x 2.0x101; 1x 2.5x112; 1x 3.0x123; 1x 4.0x137; 1x 5.0x154; 1x 6.0x172; 1x 8.0x195; 1x 10.0x224
1x 967/9 TX XL Multicolour 1	
⊕ 967 SXL TORX® Multicolour	1x TX 8x90; 1x TX 9x101; 1x TX 10x112
⊕ 967 SPKXL TORX® Multicolour	1x TX 15x123; 1x TX 20x137; 1x TX 25x154; 1x TX 27x172; 1x TX 30x195; 1x TX 40x224
1x 9500	
	1x 64,6
1x STABILA® Taschenbandmaß BM 100, 3 m, Artikel 19570	
	1x 3000,0
1x 9840	
	1x 172,0x30,0x392,0

9780 Schaumstoffeinlage KNIPEX Zangen Set 1



05150180001		
	KNIPEX Kombizange 03 05 180	1x 180
	KNIPEX Cobra® Hightech-Wasserpumpenzange 87 05 250	1x 250
	KNIPEX Kraft-Seitenschneider 74 05 160	1x 160
	9880	1x 172,0x30,0x392,0

9782 Schaumstoffeinlage Hammer Set 1

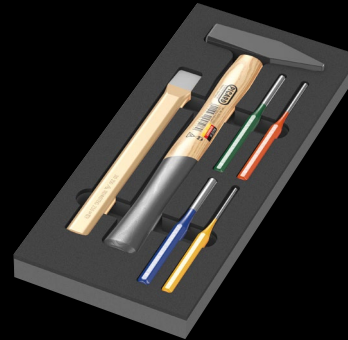

05150182001		
	PICARD® Schlosserhammer 500 g, 0000101-500	1x 500,0
	RENNSTEIG Splintentreiber Exklusiv	1x 452 003 6 RC, 3,0x150; 1x 4520046RC, 4,0x150; 1x 4520066RC, 6,0x150;
	RENNSTEIG Flachmeißel 310 250 1	1x 25,0x13,0x23,0
	9882	1x 172,0x30,0x392,0

9781 Schaumstoffeinlage KNIPEX Zangen Set 2

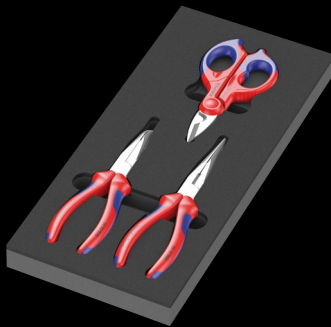

05150181001		
	KNIPEX Flachrundzange mit Schneide (Storchschnabelzange) 26 15 200	1x 200
	KNIPEX Mechanikerzange 38 25 200	1x 200
	KNIPEX Elektrikerschere 95 05 155	1x 155
	9881	1x 172,0x30,0x392,0

9783 Schaumstoffeinlage PFERD Feilen Set 1

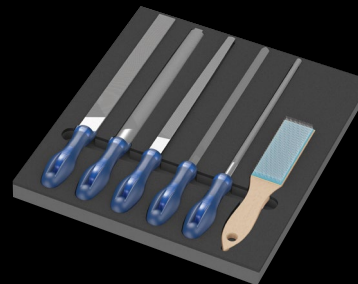

05150183001		
	PFERD Werkstattfeile vierkant PF1142 250 H2	1x 250
	PFERD Werkstattfeile halbrund-spitz 1152SP 250 H2	1x 250
	PFERD Werkstattfeile rund 1162 250 H2	1x 250
	PFERD Werkstattfeile flachstumpf 1112 250 H2	1x 250
	PFERD Werkstattfeile dreikant 1132 250 H2	1x 250
	PFERD Feilenbürste HBF Stahl-Draht Ø 0,15	1x 232
	9883	1x 344,0x30,0x392,0



Individuelle Schaumstoffeinlagen

Maßgefertigte Schaumstoffeinlagen sind ebenfalls möglich und können hier konfiguriert werden: shop.tecsafe.de/wera/

Wir behalten uns das Recht vor, alle in diesem Katalog gemachten Angaben bzgl. Produktmerkmalen, Varianten und Ausführungen jederzeit und ohne Vorankündigung zu ändern. Eine Haftung für Druckfehler oder Irrtümer wird ausgeschlossen.



Wera Werkzeuge GmbH
Korzter Straße 21–25
D-42349 Wuppertal

Phone: +49 (0)202/4045-0
E-Mail: info@wera.de
www.wera.de



DE 05 510260 024 - 0053701 - 01