

Инструментальная тележка и ложементы



Укомплектованная инструментальная тележка: продуманная конструкция и суперкачественное исполнение.

- Эксклюзивная инструментальная тележка, выполненная в дизайне Tool Rebel
- Особо жёсткая конструкция за счёт использования двойных стенок
- 7 выдвижных ящиков (5 плоских, 2 глубоких) – в том числе 2 плоских ящика с ложементами и инструментами
- Размеры плоского ящика (ширина x высота x глубина): 522 x 81 x 398 мм
- Размеры глубокого ящика (ширина x высота x глубина): 522 x 166 x 398 мм
- Полное выдвижение ящика с шариковыми направляющими и доводчиком
- Каждый ящик надёжно укрыт защитной плёнкой
- Минимальный риск опрокидывания за счёт блокировки выдвижения – открывается только один ящик, выдвинуть одновременно несколько ящиков невозможно
- Высококачественные износостойкие ложементы, без химических испарений
- Оптимальная форма ячеек для удобного извлечения инструментов из ложемента





9700 Tool Rebel Инструментальная тележка 1



Эксклюзивная инструментальная тележка, выполненная в дизайне Tool Rebel. 5 плоских и 2 глубоких выдвижных ящиков обеспечивают эффективную и мобильную работу с инструментом и материалами. Жёсткая конструкция за счёт использования двойных стенок и сварного соединения всего корпуса. Для каждодневной работы с высокой нагрузкой. Установлены 4 ложементы Wera: 9710 ложемент с набором отвёрток 1, 9720 ложемент 8000 А набор с трещоткой Zyklor 1, 9731 ложемент 6003 набор комбинированных ключей Joker 1, 9740 ложемент с набором Г-образных ключей 1.

05150130001 1x 9700 Tool Rebel Инструментальная тележка 1

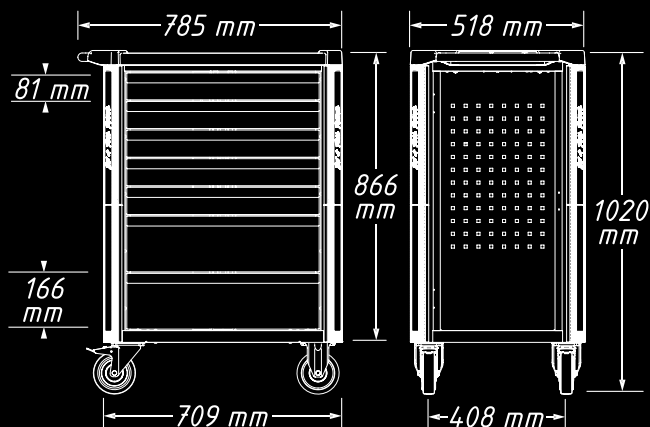

Включены следующие ложементы:

9710



9720

1/4"

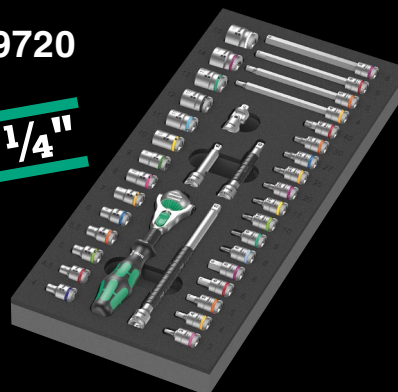

9731

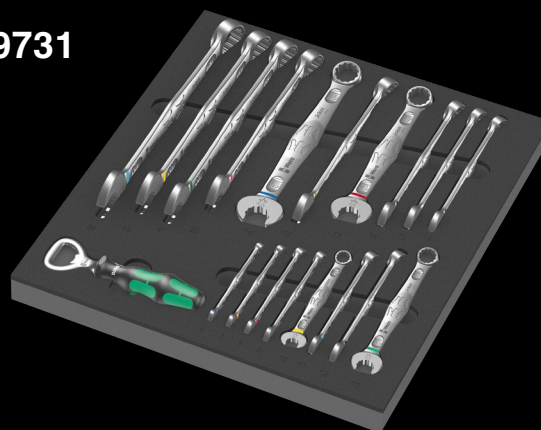

9740



НОВИНКА

9714 Ложемент Отвёртка-резец набор 1

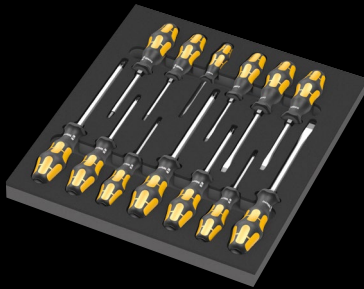

05150105001		
+	917 SPH	1x PH 1x80; 1x PH 2x100; 1x PH 3x150
+	918 SPZ	1x PZ 1x80; 1x PZ 2x100; 1x PZ 3x150
-	932 A	1x 0,6x3,5x80 ¹⁾ ; 1x 0,8x4,5x90; 1x 1,0x5,5x100; 1x 1,2x7,0x125; 1x 1,6x9,0x150
+	977 TORX®	1x TX 20x90; 1x TX 25x100
	9814	1x 344,0x30,0x392,0

¹⁾ Стержень шестигранный, не сквозной, без ударного набалдашника, без вспомогательного шестигранныка

НОВИНКА

9715 Ложемент Отвёртка Kraftform Micro набор 1

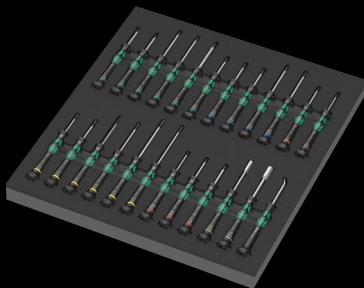

05150106001		
+	2050 Micro	1x PH 000x40 ^{1) 2)} ; 1x PH 00x40 ^{1) 2)} ; 1x PH 0x40 ³⁾
+	2067 TORX® HF	1x TX 5x40; 1x TX 6x40; 1x TX 7x60; 1x TX 8x60; 1x TX 10x60
+	2067 TORX PLUS® IPR Micro	1x 1 IPRx40 ⁴⁾
+	2072 Micro	1x mx40
○	2054 Micro	1x 0,7x40; 1x 0,9x40; 1x 1,3x40; 1x 1,5x60; 1x 2x60
-	2035 Micro	1x 0,23x1,5x40; 1x 0,30x1,8x60; 1x 0,35x2,5x40; 1x 0,40x2,0x60; 1x 0,40x2,5x80; 1x 0,50x3,0x80
●	2069 Micro	1x 4,0x60; 1x 5,5x60
●	1429	1x 1,0x3,5x50
	9815	1x 344,0x30,0x392,0

¹⁾ Оптимизированы для азиатских винтов PH

²⁾ Рабочий конец со стороны отвода обточен до номинального размера на длину 10 мм

³⁾ Размер 0 модифицирован в соответствии со стандартом JCIS 0 (Japanese Camera Industrial Standard)

⁴⁾ Без отверстия

НОВИНКА

9726 Ложемент 8007 B VDE Трещотка Zyklop VDE 3/8" набор 1



05150116001		
○	8007 B VDE	1x 3/8"x222,0
○	410 i VDE B	1x 3/8"x130
●	8790 B VDE	1x 6,0x46,0; 1x 7,0x46,0; 1x 8,0x46,0; 1x 9,0x46,0; 1x 10,0x46,0; 1x 11,0x46,0; 1x 12,0x46,0; 1x 13,0x46,0; 1x 14,0x46,0; 1x 15,0x46,0; 1x 16,0x46,0; 1x 17,0x46,0; 1x 18,0x46,0; 1x 19,0x46,0
+	8767 B VDE HF	1x TX 20x55,0; 1x TX 25x55,0; 1x TX 27x55,0; 1x TX 30x55,0; 1x TX 40x55,0; 1x TX 45x59,0
○	8740 B VDE HF	1x 4,0x55,0; 1x 5,0x55,0; 1x 6,0x55,0; 1x 8,0x59,0
○	8794 SB VDE	1x 3/8"x91,0
○	8794 LB VDE	1x 3/8"x166,0
	9826	1x 344,0x30,0x392,0

НОВИНКА

9734 Ложемент 6004 Joker VDE набор 1



05150124001		
	6004 Joker VDE XS	1x 7-10 (1/4"-3/8")x119
	6004 Joker VDE S	1x 10-13 (7/16"-1/2")x155
	6004 Joker VDE M	1x 13-16 (1/2"-5/8")x190
	6004 Joker VDE L	1x 16-19 (5/8"-3/4")x226
	9834	1x 172,0x30,0x392,0

Внимание: ложемент не подходит к предыдущей модели инструментальной тележки 05501051001.

НОВИНКА

9751 Ложемент Kraftform Kompakt VDE набор 1

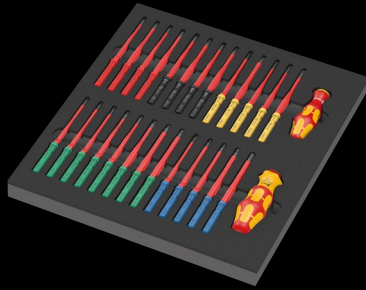

05150151001		
●	837 i RA	1x 9x115
●	817 VDE	1x 9x98
⊕	Kraftform Kompakt VDE 62 iS Take it easy	1x PH 1x157; 1x PH 2x157
⊕	Kraftform Kompakt VDE 65 iS Take it easy	1x PZ 1x157; 1x PZ 2x157
⊕	Kraftform Kompakt VDE 62 iS PH/S Take it easy	1x # 1x157; 1x # 2x157
⊕	Kraftform Kompakt VDE 65 iS PZ/S Take it easy	1x # 1x157; 1x # 2x157
⊕	Kraftform Kompakt VDE 67 i Take it easy	1x TX 8x157; 1x TX 9x157; 1x TX 10x157; 1x TX 27x157; 1x TX 30x157
⊕	Kraftform Kompakt VDE 67 iS Take it easy	1x TX 15x157; 1x TX 20x157; 1x TX 25x157
○	Kraftform Kompakt VDE 64 i Take it easy	1x 2,5x157; 1x 3,0x157; 1x 4,0x157; 1x 5,0x157; 1x 6,0x157
⊖	Kraftform Kompakt VDE 60 iS Take it easy	1x 0,6x3,5x157; 1x 0,8x4,0x157; 1x 1,0x5,5x157
⊖	Kraftform Kompakt VDE 60 i Take it easy	1x 0,4x2,5x157; 1x 1,2x6,5x157
	9851	1x 344,0x30,0x392,0

НОВИНКА

9724 Ложемент 8010 В трещотка Zyklor Comfort набор 1, 3/8"



3/8"



05150114001		
○	8010 B	1x 3/8"x230,0
●	8790 B Impaktor	1x 8,0x30,0; 1x 10,0x30,0; 1x 11,0x30,0; 1x 12,0x30,0; 1x 13,0x30,0; 1x 14,0x30,0; 1x 15,0x30,0; 1x 16,0x30,0; 1x 17,0x30,0; 1x 18,0x30,0; 1x 19,0x30,0; 1x 21,0x32,0; 1x 22,0x32,0; 1x 24,0x32,0
●○	8798 B	1x 3/8"x152,4
	9824	1x 172,0x30,0x392,0

НОВИНКА

9725 Ложемент Торцовая головка Zyklor C, 1/2", Impaktor Deep набор 1



05150115001		
●	8790 C Impaktor Deep	1x 13,0x83,0; 1x 14,0x83,0; 1x 15,0x83,0; 1x 16,0x83,0; 1x 17,0x83,0; 1x 18,0x83,0; 1x 19,0x83,0; 1x 21,0x83,0; 1x 22,0x83,0; 1x 24,0x83,0; 1x 27,0x83,0
	9825	1x 172,0x30,0x392,0

НОВИНКА

9733 Ложемент 6001 Joker Switch набор 1

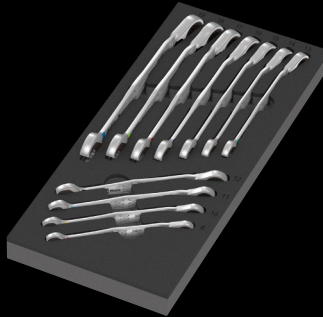

05150123001	
6001 Joker Switch	1x 8x144; 1x 10x159; 1x 11x165; 1x 12x171; 1x 13x179; 1x 14x187; 1x 15x199; 1x 16x213; 1x 17x225; 1x 18x234; 1x 19x246
9833	1x 172,0x30,0x392,0

НОВИНКА

9784 Ложемент Набор инструментов KNIPEX VDE 1



05150184001	
	Боковые кусачки KNIPEX 70 06 160
	Динногубцы Аист KNIPEX 26 16 200
	Пассатижи KNIPEX 08 26 185
9884	1x 172,0x30,0x392,0

НОВИНКА

9752 Ложемент Трещоточный набор Kraftform Компакт 1



1/4"

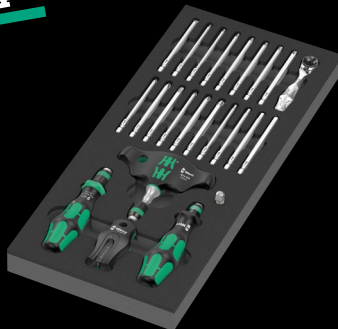

05150152001	
838 RA-R M	1x 1/4"x123,5
416 RA	1x 1/4"x45
816 R	1x 1/4"x119
8001 A	1x 1/4"x87,0
851/4 Z	1x PH 1x89; 1x PH 2x89; 1x PH 3x89 ¹⁾
855/4 Z	1x PZ 1x89; 1x PZ 2x89; 1x PZ 3x89 ¹⁾
867/4 Z TORX®	1x TX 10x89; 1x TX 15x89; 1x TX 20x89; 1x TX 25x89; 1x TX 27x89; 1x TX 30x89; 1x TX 40x89
840/4 Z	1x 3,0x89; 1x 4,0x89; 1x 5,0x89; 1x 6,0x89 ¹⁾
800/4 Z	1x 1,0x5,5x89
870/1	1x 1/4"x25 ²⁾
9500	1x 64,6
9852	1x 172,0x30,0x392,0

¹⁾ Шестигранный стержень

²⁾ С шариковым фиксатором; для торцевых головок, используемых в ручном режиме

9710 Ложемент набор отвёрток 1



05150101001	
932 A	1x 1,0x5,5x100; 1x 1,2x7,0x125
350 PH	1x PH 1x80; 1x PH 2x100; 1x PH 3x150
350 PH Stubby	1x PH 2x25
355 PZ	1x PZ 1x80; 1x PZ 2x100
335	1x 0,8x4,0x100; 1x 1,0x5,5x125
334	1x 1,2x6,5x150
335 Отвёртка для карбюраторов / Stubby	1x 1,0x5,5x24,5
2050 Micro	1x PH 0x40 ¹⁾
2035 Micro	1x 0,40x2,5x80
160 i VDE	1x 0,4x2,5x80 ²⁾ ; 1x 0,6x3,5x100 ²⁾
1441	1x 4,5-6,0x41,0
1442	1x 6,0-8,5x41,0
9810	1x 344,0x30,0x392,0

¹⁾ Размер 0 модифицирован в соответствии со стандартом JCS 0 (Japanese Camera Industrial Standard)

²⁾ без Lasertip

9711 Ложемент набор отвёрток VDE 1

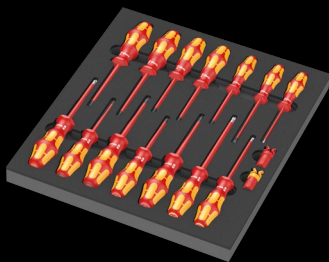

05150102001	
+	162 iS PH VDE 1x PH 1x80; 1x PH 2x100
+	165 iS PZ VDE 1x PZ 1x80; 1x PZ 2x100
+	165 i PZ/S VDE 1x # 2x100
-	160 i VDE 1x 0,4x2,5x80 ¹⁾ ; 1x 0,8x4,0x100; 1x 1,0x5,5x125
-	160 iS VDE 1x 0,6x3,5x100
+	167 i TORX® VDE 1x TX 10x80; 1x TX 15x80; 1x TX 20x80; 1x TX 25x100; 1x TX 30x100
	1440 1x 4,5-6,0x41,0
	1442 1x 6,0-8,5x41,0
	9811 1x 344,0x30,0x392,0

¹⁾ без Lasertip

9713 Ложемент набор отвёрток Hex 1

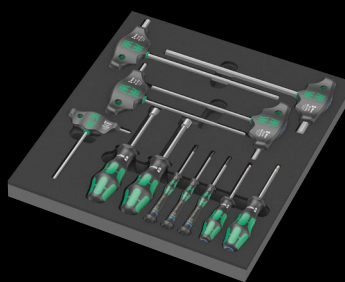

05150104001	
○	354 1x 3,0x75; 1x 4,0x75
○	2054 Micro 1x 1,5x60; 1x 2x60; 1x 2,5x60
○	454 HF 1x 4x100; 1x 5x100; 1x 6x150; 1x 8x200; 1x 10x200
●	395 H0 1x 10,0x90; 1x 13,0x90
	9813 1x 344,0x30,0x392,0

9720 Ложемент набор 8000 А трещотка 1/4" Zyklop 1



9712 Ложемент набор отвёрток TORX® HF 1

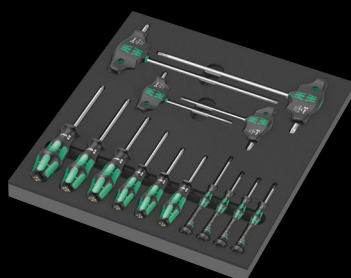

05150103001	
+	367 TORX® HF 1x TX 8x60; 1x TX 9x60; 1x TX 10x80; 1x TX 15x80; 1x TX 20x100; 1x TX 25x100
+	2067 TORX® HF 1x TX 4x40; 1x TX 5x40; 1x TX 6x40; 1x TX 7x60
+	467 TORX® HF 1x TX 20x100; 1x TX 25x100; 1x TX 30x200; 1x TX 40x200
	9812 1x 344,0x30,0x392,0

05150110001	
○	8000 A 1x 1/4"x152,0
●○	8794 LA 1x 1/4"x150,0
●○	8794 SA 1x 1/4"x75,0
●○	8795 A 1x 1/4"x35,5
●○	8794 A 1x 1/4"x56,0
●	8790 HMA 1x 4,0x23,0; 1x 4,5x23,0; 1x 5,0x23,0; 1x 5,5x23,0; 1x 6,0x23,0; 1x 7,0x23,0; 1x 8,0x23,0; 1x 9,0x23,0; 1x 10,0x23,0; 1x 11,0x23,0; 1x 12,0x23,0; 1x 13,0x23,0; 1x 14,0x23,0; 1x 15,0x23,0
+	8767 A HF 1x TX 8x28,0; 1x TX 9x28,0; 1x TX 10x28,0; 1x TX 15x28,0; 1x TX 20x28,0; 1x TX 25x28,0; 1x TX 27x28,0; 1x TX 30x28,0; 1x TX 40x28,0
○	8740 A HF 1x 3,0x28,0; 1x 4,0x28,0; 1x 4,0x100,0; 1x 5,0x28,0; 1x 5,0x100,0; 1x 6,0x28,0; 1x 6,0x100,0; 1x 8,0x28,0; 1x 8,0x100,0
	9820 1x 172,0x30,0x392,0

9721 Ложемент набор 8000 В трещотка 3/8" Zyklor 1



05150111001		
○	8000 B	1x 3/8"x199,0
●○	8794 SB	1x 3/8"x125,0
●○	8794 LB	1x 3/8"x200,0
●○	8795 B	1x 3/8"x50,0
●○	8794 B	1x 3/8"x76,0
●	8790 HMB	1x 6,0x29,0; 1x 7,0x29,0; 1x 8,0x29,0; 1x 9,0x29,0; 1x 10,0x29,0; 1x 11,0x29,0; 1x 12,0x29,0; 1x 13,0x29,0; 1x 14,0x29,0; 1x 15,0x29,0; 1x 16,0x30,0; 1x 17,0x30,0; 1x 18,0x30,0; 1x 19,0x30,0; 1x 20,0x30,0; 1x 21,0x30,0; 1x 22,0x30,0; 1x 24,0x32,0
	9821	1x 172,0x30,0x392,0

9723 Ложемент набор отвёрточных головок Zyklor 3/8" В 1



05150113001		
●●	8784 B1	1x 1/4"x3/8"x44,0
⊗	8767 B HF	1x TX 15x35,0; 1x TX 20x35,0; 1x TX 25x35,0; 1x TX 25x107,0; 1x TX 27x35,0; 1x TX 27x107,0; 1x TX 30x35,0; 1x TX 30x107,0; 1x TX 40x35,0; 1x TX 40x107,0
○	8740 B HF	1x 4,0x35,0; 1x 4,0x107,0; 1x 5,0x35,0; 1x 5,0x107,0; 1x 6,0x35,0; 1x 6,0x107,0; 1x 7,0x38,5; 1x 8,0x38,5; 1x 8,0x100,0; 1x 10,0x38,5; 1x 10,0x100,0
	9823	1x 172,0x30,0x392,0

9722 Ложемент набор 8000 С трещотка 1/2" Zyklor 1



05150112001		
○	8000 C	1x 1/2"x277,0
●○	8794 LC	1x 1/2"x250,0
●○	8794 SC	1x 1/2"x125,0
●○	8795 C	1x 1/2"x69,0
●○	8794 C	1x 1/2"x52,0
●	8790 HMC	1x 10,0x37,0; 1x 11,0x37,0; 1x 12,0x37,0; 1x 13,0x37,0; 1x 14,0x37,0; 1x 15,0x37,0; 1x 16,0x37,0; 1x 17,0x37,0; 1x 18,0x37,0; 1x 19,0x37,0; 1x 20,0x37,0; 1x 21,0x37,0; 1x 22,0x37,0; 1x 24,0x37,0; 1x 27,0x40,0; 1x 30,0x42,0; 1x 32,0x42,0
○	8740 C HF	1x 4,0x60,0; 1x 4,0x140,0; 1x 5,0x60,0; 1x 5,0x140,0; 1x 6,0x60,0; 1x 6,0x140,0; 1x 7,0x60,0; 1x 8,0x60,0; 1x 10,0x60,0
	9822	1x 344,0x30,0x392,0

9730 Ложемент набор 6000 Joker 1



05150120001		
	6000 Joker	1x 8x144; 1x 10x159; 1x 11x165; 1x 12x170,7; 1x 13x177; 1x 14x188; 1x 15x200; 1x 16x212; 1x 17x224; 1x 18x235; 1x 19x246
	9830	1x 172,0x30,0x392,0

9731 Ложемент набор 6003 Joker 1



05150121001		
	6003 Joker	1x 6x105; 1x 7x110; 1x 8x115; 1x 9x120; 1x 10x125; 1x 11x135; 1x 12x148; 1x 13x160; 1x 14x167; 1x 15x174; 1x 16x182; 1x 17x190; 1x 18x210; 1x 19x230,0; 1x 20x230,0; 1x 21x260; 1x 22x260; 1x 24x280
	Открывалки	1x 148
	9831	1x 344,0x30,0x392,0

9732 Ложемент набор 6004 Joker 1



05150122001		
	6004 Joker XS	1x 7-10 (1/4"-3/8")x117
	6004 Joker S	1x 10-13 (7/16"-1/2")x154
	6004 Joker M	1x 13-16 (1/2"-5/8")x188
	6004 Joker L	1x 16-19 (5/8"-3/4")x224
	6004 Joker XL	1x 19-24x (3/4"-15/16")x256
	9832	1x 172,0x30,0x392,0

9740 Ложемент набор Г-образных ключей 1



9750 Ложемент набор Kraftform Kompakt и Tool-Check PLUS 1



05150150001		
	1x Tool-Check PLUS	
	● 8001 A	1x 1/4"x87.0
	● 813	1x 1/4"x78
	● 889/4/1 K	1x 1/4"x50
	○ 870/1	1x 1/4"x25 ¹⁾
	● 8790 HMA	1x 5.5x23.0; 1x 6.0x23.0; 1x 7.0x23.0; 1x 8.0x23.0; 1x 10.0x23.0; 1x 12.0x23.0; 1x 13.0x23.0
	⊕ 851/1 TZ	2x PH 1x25; 3x PH 2x25; 1x PH 3x25
	⊕ 855/1 TH	1x PZ 1x25; 3x PZ 2x25; 1x PZ 3x25
	⊗ 867/1 TZ TORX®	1x TX 10x25; 1x TX 15x25; 1x TX 20x25; 1x TX 25x25; 1x TX 30x25; 1x TX 40x25
	⊗ 867/1 Z TORX® BO	1x TX 10x25; 1x TX 15x25; 1x TX 20x25; 1x TX 25x25; 1x TX 30x25
	○ 840/1 Z	1x 3.0x25; 1x 4.0x25; 1x 5.0x25; 1x 6.0x25; 1x 8.0x25
	⊖ 800/1 TZ	1x 1.0x5.5x25
	1x Kraftform Kompakt 60	
	● 816 R	1x 1/4"x119
	⊕ 851/4 Z	1x PH 1x89; 1x PH 2x89; 1x PH 3x89 ²⁾
	⊕ 855/4 Z	1x PZ 1x89; 1x PZ 2x89; 1x PZ 3x89 ²⁾
	⊗ 867/4 Z TORX® BO	1x TX 10x89; 1x TX 15x89; 1x TX 20x89; 1x TX 25x89; 1x TX 30x89
	⊖ 800/4 Z	1x 1.0x5.5x89
	○ 840/4 Z	1x 3.0x89; 1x 4.0x89; 1x 5.0x89; 1x 6.0x89 ²⁾
	Набор полосок на липучках 70	1x 50.0x70.0
	1x 393 S	
	●	1x 1/4"x173,5
	1x 9850	
		1x 172,0x30,0x392,0

¹⁾ С шариковым фиксатором; для торцовых головок, используемых в ручном режиме

²⁾ Шестигранный стержень

05150140001		
	1x 950/9 Hex-Plus Multicolour 1	
	○ 950 SPKL Multicolour	1x 1.5x90; 1x 2.0x101; 1x 2.5x112; 1x 3.0x123; 1x 4.0x137; 1x 5.0x154; 1x 6.0x172; 1x 8.0x195; 1x 10.0x224
	1x 967/9 TX XL Multicolour 1	
	⊗ 967 SXL TORX® Multicolour	1x TX 8x90; 1x TX 9x101; 1x TX 10x112
	⊗ 967 SPKXL TORX® Multicolour	1x TX 15x123; 1x TX 20x137; 1x TX 25x154; 1x TX 27x172; 1x TX 30x195; 1x TX 40x224
	1x 9500	
		1x 64,6
	1x Измерительная рулетка STABILA® VM 100, 3 м, артикул 19570	
		1x 3000,0
	1x 9840	
		1x 172,0x30,0x392,0

9780 Ложемент набор инструментов KNIPEX 1

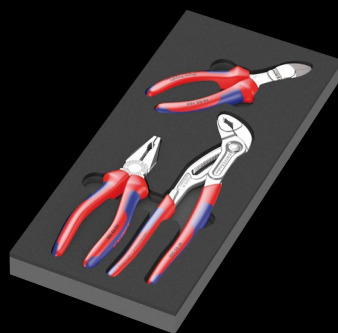

05150180001	Плоскогубцы 1x 180 комбинированные KNIPEX 03 05 180
	Сантехнические клещи KNIPEX Cobra® 87 05 250
	Боковые кусачки особой мощности KNIPEX 74 05 160
9880	1x 172,0x30,0x392,0

9782 Ложемент набор молотков 1



05150182001	Молоток слесарный PICARD® 500 г, 0000101-500	1x 500,0
	Выколотки для шпильков RENNSTEIG 1x 452 003 6 RC, 3,0x150; 1x 452 004 6 RC, 4,0x150; 1x 452 006 6 RC, 6,0x150; RENNSTEIG 1x 452 008 6 RC, 8,0x150	Exklusiv
	Плоское зубило RENNSTEIG 310 250 1	1x 25,0x13,0x23,0
9882	1x 172,0x30,0x392,0	

9781 Ложемент набор инструментов KNIPEX 2

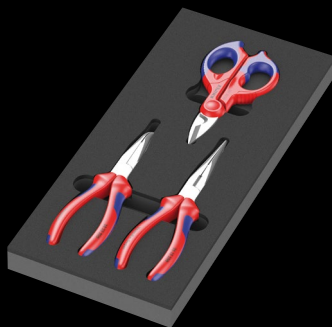

05150181001	Длинногубцы 1x 200 с прямыми полукруглыми длинными губками с режущей кромкой KNIPEX 26 15 200
	Плоскогубцы механика KNIPEX 38 25 200
	Ножницы электрика KNIPEX 95 05 155
9881	1x 172,0x30,0x392,0

9783 Ложемент набор напильников PFERD 1

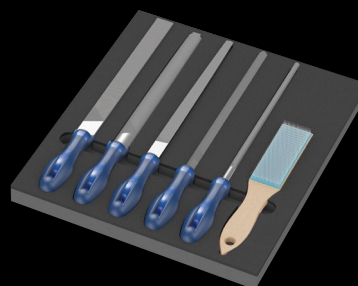

05150183001	Напильник квадратный PFERD PF1142 250 H2	1x 250
	Напильник полукруглый PFERD 1152SP 250 H2	1x 250
	Напильник круглый PFERD 1162 250 H2	1x 250
	Напильник плоский PFERD 1112 250 H2	1x 250
	Напильник трёхгранный PFERD 1132 250 H2	1x 250
	Щётка PFERD HBF, для очистки напильников, стальная проволока Ø 0,15	1x 232
9883	1x 344,0x30,0x392,0	

Оставляем за собой право изменения в любое время и без предварительного уведомления всех предоставленных в этом каталоге данных касательно характеристик изделий, вариантов и исполнений. Компания Wera не несет ответственности за возможные опечатки и ошибки в оформлении.



Wera Werkzeuge GmbH
Korzarter Straße 21–25
D-42349 Wuppertal

Phone: +49 (0)202/4045-0
E-Mail: info@wera.de
www.wera.de