

Great tools for Tool Rebels



A little about us

At Wera, we believe in challenging the standard.

We are innovators. Worldwide, many believe we are best in our class. We boast some of the best product designers & engineers. We develop groundbreaking tools that push boundaries.

Our drive to transform the mundane into the extraordinary is limitless, and we want you to be a part of our team.

If all you want is a screwdriver, we can do that. But if you want more, if you demand more, then you've come to the right place.

We challenge the standard by making the experience for our users easier, safer and full of joy!

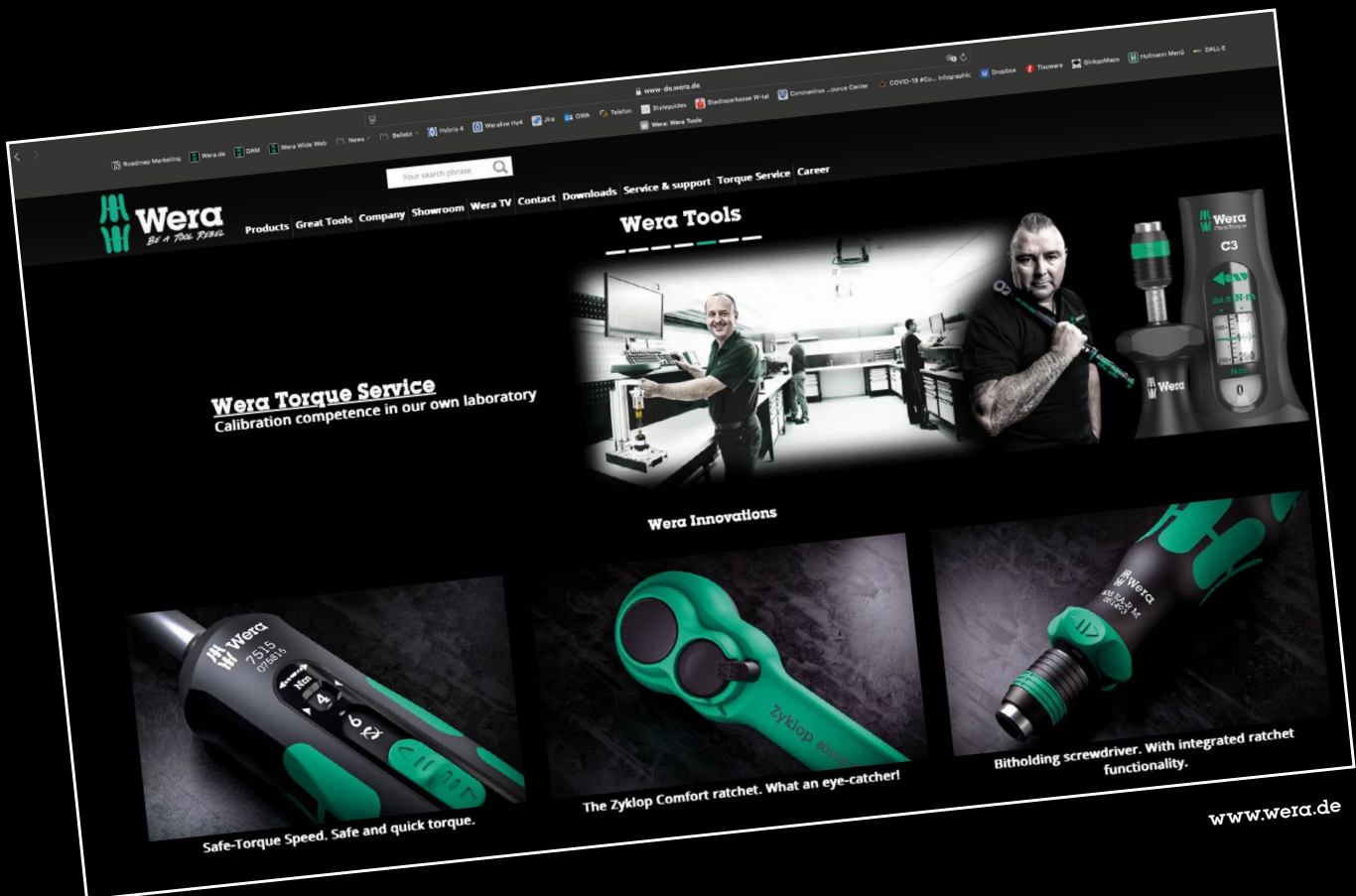



Summer Breeze 2024



Hot Air Balloon

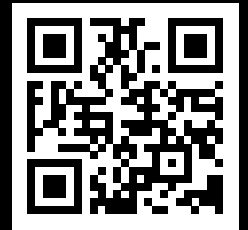

@weratoolrebels



6004 Joker 4 set 1 Self-setting spanner set



Self-setting spanner set
4-piece set
In robust folding pouch

05020110001	
	6004 Joker XS 1x 7-10 ($\frac{1}{4}''$ - $\frac{3}{8}''$)x117
	6004 Joker S 1x 10-13 ($\frac{7}{16}''$ - $\frac{1}{2}''$)x154
	6004 Joker M 1x 13-16 ($\frac{1}{2}''$ - $\frac{5}{8}''$)x188
	6004 Joker L 1x 16-19 ($\frac{5}{8}''$ - $\frac{3}{4}''$)x224

6004 Joker VDE 4 Set 1 VDE-insulated self-setting spanner set



VDE-insulated self-setting spanner set
4-piece set
In a robust textile box

05020170001	
	6004 Joker VDE XS 1x 7-10 ($\frac{1}{4}''$ - $\frac{3}{8}''$)x119
	6004 Joker VDE S 1x 10-13 ($\frac{7}{16}''$ - $\frac{1}{2}''$)x155
	6004 Joker VDE M 1x 13-16 ($\frac{1}{2}''$ - $\frac{5}{8}''$)x190
	6004 Joker VDE L 1x 16-19 ($\frac{5}{8}''$ - $\frac{3}{4}''$)x226
	Hook and Loop Fastener Strip 120



Joker 6004: Automatically and continuously self-setting

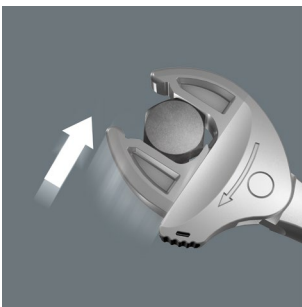

With its automatically and continuously gripping parallel jaws the Joker spanner 6004 covers all dimensions in the respective field of application. The tool automatically finds the required size when placed on the bolt or screw, no setting required.



Joker 6004: Ratchet mechanism for fast work

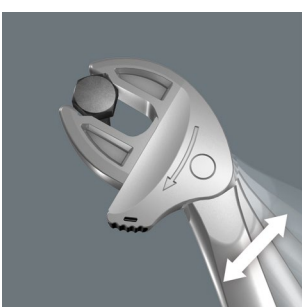

The ratchet functionality in the open end sees to fast and consistent screwdriving without removing the tool.

Safe opening of the jaws

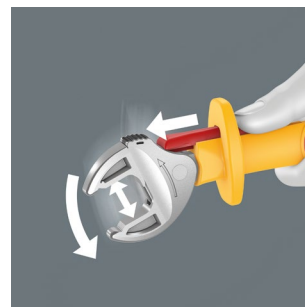

The sliding function allows contactless and safe opening of the non-insulated jaws.

2-component plastic insulation



The 2-component plastic insulation of the lever ensures a comfortable feel and a non-slip hold.

6004 Joker XS Self-setting spanner



Application: Hexagon screw heads and bolts with wrench size 7-10 (metric) or 1/4"-3/8" (imperial)

Design: Self-setting spanner with ratchet function; size-adjustable open end side, parallel smooth jaws, with 30° return angle due to the corner-width rectangular prisms in the jaws; hole for hanging

	mm	mm	mm	mm
05020099001	7-10	1/4"-3/8"	117	7,7

6004 Joker S Self-setting spanner



Application: Hexagon screw heads and bolts with wrench size 10-13 (metric) or 7/16"-1/2" (imperial)

Design: Self-setting spanner with ratchet function; size-adjustable open end side, parallel smooth jaws; with 30° return angle due to the corner-width rectangular prisms in the open end; hole for hanging

	mm	mm	mm	mm
05020100001	10-13	7/16"-1/2"	154	10

6004 Joker M Self-setting spanner



Application: Hexagon screw heads and bolts with wrench size 13-16 (metric) or 1/2"-5/8" (imperial)

Design: Self-setting spanner with ratchet feature; size-adjustable open end side, parallel smooth jaws, with 30° return angle due to the corner-width rectangular prisms in the open end; hole for hanging

	mm	mm	mm	mm
05020103001	13-16	1/2"-5/8"	188	12,4

6004 Joker L Self-setting spanner



Application: Hexagon screw heads and bolts with wrench size 16-19 (metric) or 5/8"-3/4" (imperial)

Design: Self-setting spanner with ratchet function; size-adjustable open end side, parallel smooth jaws; with 30° return angle due to the corner-width rectangular prisms in the open end; hole for hanging

	mm	mm	mm	mm
05020101001	16-19	5/8"-3/4"	224	14

6004 Joker XL Self-setting spanner



Application: Hexagon screw heads and bolts with wrench size 19-24 (metric) or 3/4"-15/16" (imperial)

Design: Self-setting spanner with ratchet function; size-adjustable open end side, parallel smooth jaws; with 30° return angle due to the corner-width rectangular prisms in the jaws; hole for hanging

	mm	mm	mm	mm
05020104001	19-24	3/4"-15/16"	256	16

6004 Joker XXL Self-setting spanner



Application: Hexagon screw heads and bolts with wrench size 24-32 (metric) or 15/16"-1 1/4" (imperial)

Design: Self-setting spanner with ratchet function; size-adjustable open end side, parallel smooth jaws; with 30° return angle due to the corner-width rectangular prisms in the jaws; hole for hanging

	mm	mm	mm	mm
05020102001	24-32	15/16"-1 1/4"	322	20

6004 Joker VDE XS VDE-insulated, self-setting spanner



Application: Hexagonal screw heads and bolts with wrench sizes 7-10 (metric) or 1/4"-3/8" (imperial)

Design: Insulated, individually tested as per IEC 60900; 2-component plastic foam insulation; self-setting spanner with ratchet function; mouth side adjustable in size, parallel smooth jaws; with 30° back-pivoting angle via the corner-width prisms in the jaws; anti-slip protection at the front end of the handle; sliding function for contactless and safe opening of the non-insulated jaws; hole for hanging

	mm		mm	mm
05020150001	7-10	1/4"-3/8"	119	7,7

6004 Joker VDE S VDE-insulated, self-setting spanner



Application: Hexagonal screw heads and bolts with wrench sizes 10-13 (metric) or 7/16"-1/2" (imperial)

Design: Insulated, individually tested as per IEC 60900; 2-component plastic foam insulation; self-setting spanner with ratchet function; open end side adjustable in size, parallel smooth jaws; with 30° return angle via the corner-width prisms in the jaws; anti-slip protection at the front end of the handle; sliding function for contactless and safe opening of the non-insulated jaws; hole for hanging

	mm		mm	mm
05020151001	10-13	7/16"-1/2"	155	10

6004 Joker VDE M VDE-insulated, self-setting spanner



Application: Hexagonal screw heads and bolts with wrench sizes 13-16 (metric) or 1/2"-5/8" (imperial)

Design: Insulated, individually tested as per IEC 60900; 2-component plastic foam insulation; self-setting spanner with ratchet function; open end side adjustable in size, parallel smooth jaws; with 30° return angle via the corner-width prisms in the jaws; anti-slip protection at the front end of the handle; sliding function for contactless and safe opening of the non-insulated jaws; hole for hanging

	mm		mm	mm
05020152001	13-16	1/2"-5/8"	190	12,4

6004 Joker VDE L VDE-insulated self-setting spanner



Application: Hexagonal screw heads and bolts with wrench sizes 16-19 (metric) or 5/8"-3/4" (imperial)

Design: Insulated, individually tested as per IEC 60900; 2-component plastic foam insulation; self-setting spanner with ratchet function; open end side adjustable in size, parallel smooth jaws; with 30° return angle via the corner-width prisms in the jaws; anti-slip protection at the front end of the handle; sliding function for contactless and safe opening of the non-insulated jaws; hole for hanging

	mm		mm	mm
05020153001	16-19	5/8"-3/4"	226	14



6003 Joker Combination wrench



Application: Hexagon screw heads and bolts

Design: Combination wrench; open end side offset by 7.5°, ring side pivoted by 15°; with Take it easy tool finder: colour coding by size

6005 Joker Double open end wrench



Application: Hexagon bolts and nuts

Design: Double open end wrench; open-end sides offset by 7.5°; with Take it easy tool finder: colour coding by size

		mm	mm	mm	mm	mm	mm
05020310001		6	16	7	17,7	4	4,2
05020311001		8	19	9	21	4,5	4,8
05020312001		10	23	11	25	5	5
05020313001		12	26	13	27	5,5	6

		mm	mm	mm	mm	mm	mm
05020190001		5,5	105	16	4	10	6
05020198001		6	105	16	4	10	6
05020199001		7	110	17,7	4,2	11,5	6
05020200001		8	115	19	4,5	12,5	7
05020219001		9	120	21	4,8	13,5	7
05020201001		10	125	22	5	15	7
05020202001		11	135	24,5	5	17	8
05020203001		12	148	26	5,5	18	8,5
05020204001		13	160	27	6	19	8,5
05020205001		14	167	29	6	20	8,5
05020206001		15	174	32	6	22	8,5
05020207001		16	182	35	6,5	23	10
05020208001		17	190	38	6,5	24,5	10
05020209001		18	210	39	7,5	26	11,5
05020210001		19	230,0	42	7,5	27,5	11,5
05020500001		20	230,0	45	7,5	29	13
05020501001		21	260	47	7,5	30	13
05020502001		22	260	49	7,5	31,5	13
05020503001		24	280	53	8	36	14
05020504001		27	300	60	8,5	40	14,5
05020505001		30	330	66	9	43	16
05020506001		32	360	70	9,5	45,5	16,5
05020507001		36	460	80	10	50,5	18

6005 Joker 4 Set 1 Double open end wrench set

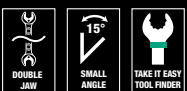

Double open end wrench set, open-end sides offset by 7.5°

4-piece set

In a handy clip

05020314001			
6005 Joker Double	1x 6x7x111,8; 1x 8x9x122,2; 1x 10x11x137,3; 1x 12x13x166		

Imperial Sizes available



6003 Joker 11 Set 1 Combination wrench set

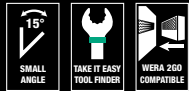

Combination wrench set, open side offset by 7.5°

11-piece set

In robust pouch

	
05020231001	
6003 Joker	1x 8x115; 1x 10x125; 1x 11x135; 1x 12x148; 1x 13x160; 1x 14x167; 1x 15x174; 1x 16x182; 1x 17x190; 1x 18x210; 1x 19x230,0
Hook and Loop Fastener Strip 240	1x 50,0x240,0

6003 Joker 5 Set 1 Combination wrench set

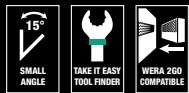

Combination wrench set, open side offset by 7.5°

5-piece set

In robust pouch

	
05020230001	
6003 Joker	1x 8x115; 1x 10x125; 1x 13x160; 1x 17x190; 1x 19x230,0
Hook and Loop Fastener Strip 120	1x 50,0x120,0

6003 Joker 4 Set 1 Combination wrench set

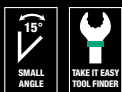

Combination wrench set, open end side offset by 7.5°

4-piece set

In a handy clip

	
05020228001	
6003 Joker	1x 8x115; 1x 10x125; 1x 12x148; 1x 13x160



For very tight spaces



The Joker 6003 ring spanner with its special open end geometry – open end offset by 7.5° and the double hexagon profile – doubles the placement possibilities when repeatedly turning the wrench 180° around the longitudinal axis. Bolts and screw heads can be "accessed" every 15°.

The Joker 6003 will automatically find the respective placement point after every turn.

Double-hex geometry

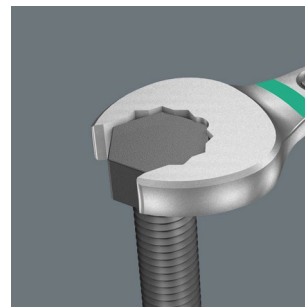

The double hexagon geometry on the open end and ring sides secures the positive connection with the screw head or bolt and reduces the risk of slipping.

Joker 6003: Tilted ring side

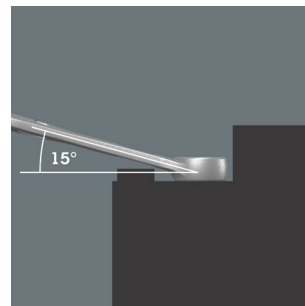

The ring side is tilted at 15° to the tool axis to prevent injury.

Suitable for docking with the Wera 2go system



The Joker pouches are suitable for attachment to walls, shelves, workshop trolleys and the Wera 2go system thanks to the hook and loop fastener system on the back.

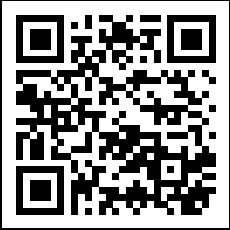

HOLDING
FUNCTION

Holding function



The Joker's holding function means that nuts and bolts can be held in the jaw and easily positioned where they are needed. Fastening on to the thread can then be done quickly and safely, thanks to the innovative special stop-plate which holds the fastener. No more time-wasting searches

for dropped nuts and bolts! After applying and positioning the nut or bolt, fastening can begin immediately – no additional tools required.

Double-hex geometry



The Joker's clever double-hex geometry delivers a very positive connection with nuts or bolts – it's a perfect fit. And the exchangeable, hardened metal gripping plate in the Joker's mouth literally bites itself into the bolt, with its extremely hard tips. Both features combine to prevent slipping, even at higher torque.

Fine tooth mechanism

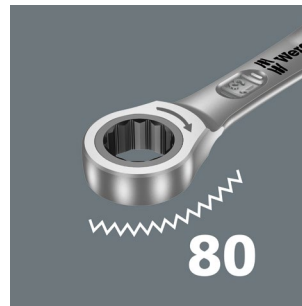

The ratcheting feature at the ring end boasts an exceptional, fine tooth mechanism – 80 teeth in all – which provides greater flexibility, even in very confined workspaces.

6000/6002 Joker 6 Set 1 Ratcheting combination / double open-end wrenches set



Ratcheting combination / double open-end wrenches set

6-piece set

Durable pouch

05020022001	
6000 Joker	1x 10x159; 1x 13x177; 1x 17x224; 1x 19x246
6002 Joker Double	1x 10x13x167; 1x 17x19x235

6001 Joker Switch 11 Set 1 Ratcheting combination wrenches set



Set of ratcheting combination wrenches, reversible

11-piece set

Durable pouch

05020091001	
6001 Joker Switch	1x 8x144; 1x 10x159; 1x 11x165; 1x 12x171; 1x 13x179; 1x 14x187; 1x 15x199; 1x 16x213; 1x 17x225; 1x 18x234; 1x 19x246
Hook and Loop Fastener Strip 240	1x 50,0x240,0

6000 Joker 4 Set 1 Ratcheting combination wrenches set



Set of ratcheting combination wrenches

4-piece set

In robust pouch

05073290001	
6000 Joker	1x 10x159; 1x 13x177; 1x 17x224; 1x 19x246

6002 Joker Double Open end wrenches



Application: Hexagon bolts and nuts

Design: Double open-end wrench

		mm	mm	mm	mm	mm	mm
05003760001		10	23	13	27	5,5	7
05003765001		17	37	19	42	8,5	9,5
05020260001		20	48	22	51	10	10
05020261001		22	48	24	51	10	10
05020262001		24	51	27	60	11	11
05020263001		27	63	32	66	12	12
05020264001		30	63	32	66	12	12



826 T Kraftform Turbo bitholding handle with Rapidaptor quick-release chuck



Application: Suitable for bits with 1/4" external hexagon drive as per DIN ISO 1173-C 6,3 and E 6,3 and Wera connection series 1 and 4

Design: Connectable mechanic turbo function for quadrupling the screwdriving speed; robust, maintenance-free gear made of steel; 1/4" - hexagon socket mounting with Rapidaptor technology with rapid-in, rapid-out, rapid-spin, chuck-all and single-hand functions, magnetic

Handle: Kraftform with anti-roll protection, multi-component

		mm
05057480001	1/4"	146

Kraftform Kompakt Turbo 1

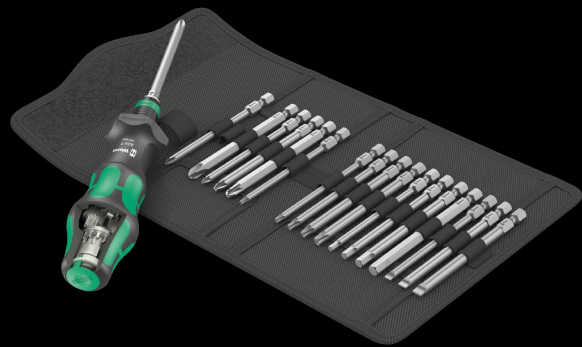

Folding pouch with 89 mm long bits

19-piece set

1 bitholding Kraftform Turbo with Rapidaptor quick-release chuck

05057482001		
	826 T Kraftform Turbo	1x 1/4"x146
	851/4 Z	1x PH 1x89; 1x PH 2x89; 1x PH 3x89 ¹⁾
	855/4 Z	1x PZ 1x89; 1x PZ 2x89; 1x PZ 3x89 ¹⁾
	867/4 Z TORX®	1x TX 10x89; 1x TX 15x89; 1x TX 20x89; 1x TX 25x89; 1x TX 30x89
	840/4 Z	1x 3,0x89; 1x 4,0x89; 1x 5,0x89; 1x 6,0x89 ¹⁾
	800/4 Z	1x 0,8x4,0x89; 1x 1,0x5,5x89; 1x 1,2x6,5x89
	Hook and Loop Fastener Strip 120	1x 50,0x120,0



Faster screwdriving

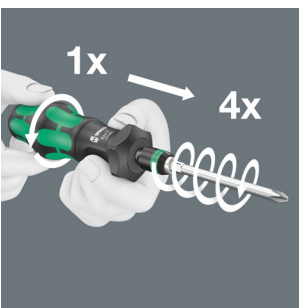

The construction of the Kraftform Turbo allows the speed of manual screwdriving to be quadrupled, especially for smooth couplings - without electricity!

With and without Turbo



The turbo function can be activated as needed by pressing a button. Turning it off is recommended for tightening and loosening with high torque, e.g. for screw connections in wood as well as for fine adjustments.

¹⁾ Hexagonal blade

827 T i Kraftform Turbo bladeholding handle



Application: For Wera VDE interchangeable blades only

Design: Connectable mechanic turbo function for quadrupling the screwdriving speed; robust, maintenance-free gear made of steel

Handle: Kraftform with anti-roll protection, multi-component

	mm	mm
05057481001	9	125

Kraftform Kompakt Turbo i 1



16-piece set

1 bladeholding 817 Kraftform VDE handle and 1 blade holding 827 T i Kraftform Turbo handle; both for Wera VDE interchangeable blades only

14 VDE interchangeable blades (each 154 mm long) with reduced blade diameter (articles KK 60 i 0,4x2,5 and KK 67 i TX 10 standard blade diameter) with integrated protective insulation, so that low-lying screw and spring elements can be reached and operated

05057484001		
	827 T i Kraftform Turbo	1x 9x125
	817 VDE	1x 9x102
	KK 62 iS	1x PH 1x154; 1x PH 2x154
	KK 65 iS PZ	1x PZ 1x154; 1x PZ 2x154
	KK 65 iS PZ/S	1x # 1x154; 1x # 2x154
	KK 67 i TORX®	1x TX 10x154
	KK 67 iS	1x TX 15x154; 1x TX 20x154; 1x TX 25x154
	KK 60 i	1x 0,4x2,5x154
	KK 60 iS	1x 0,6x3,5x154; 1x 0,8x4,0x154; 1x 1,0x5,5x154
	K120	1x 50,0x120,0



Faster screwdriving

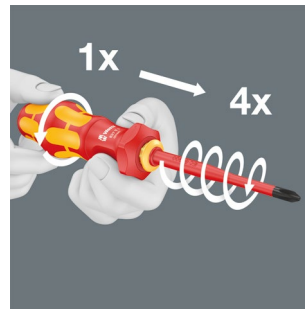

The construction of the Kraftform Turbo allows the speed of manual screwdriving to be quadrupled, especially for smooth couplings - without electricity!

With and without Turbo



The turbo function can be switched on or off at the push of a button. Turning it off is recommended for tightening and loosening with high torque as well as for fine adjustments.

Handle/interchangeable blade system

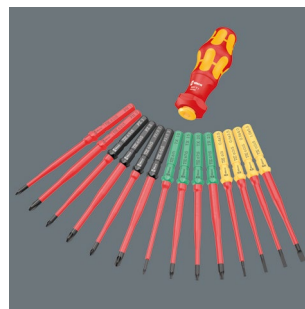

With its 9 mm mounting, the Kraftform Turbo is suitable for all Wera Kraftform Kompakt VDE interchangeable blades. The "holder/interchangeable blade system" stands for flexible working with many screw profiles.



Individually tested



The individual testing at 10,000 volts, in accordance with IEC 60900, ensures safe working with loads up to 1,000 volts.

The 837 i RA bladeholding handle with ratchet functionality



The integrated ratchet with fine toothing (40 teeth and a return angle of 9°) eases and accelerates screwdriving without having to reposition the tool.

The 817 VDE bladeholding handle

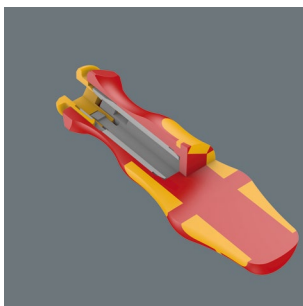

The bladeholding handle is suitable solely for Wera VDE blades. Kraftform Plus handle for comfortable ergonomic screwdriving, avoiding blisters and calluses. Hard handle zones for high working speeds, while soft handle zones guarantee a high torque transfer.

Kraftform Kompakt VDE 17 RA 1



17-piece set

One 837 i RA bladeholding handle with ratchet functionality (40 teeth, 9° return angle), one 817 VDE bladeholding screwdriver, each solely for Wera VDE blades. 15 VDE blades (each 157 mm length) with "Take it easy" Tool finder. Colour coding by profile and laser-engraved size indication



TAKE IT EASY
TOOL FINDER

"Take it easy" Tool Finder

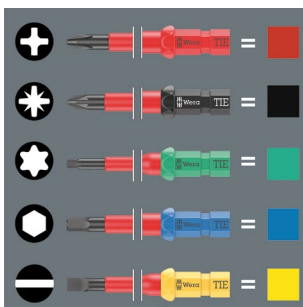

The Kraftform Kompakt VDE blades are equipped with the "Take it easy" Tool finder. The colour coding by profile and the laser-engraved size indication make it easy to identify the required tool quickly.



ANTI
ROLL-OFF

Hexagonal anti-roll feature against rolling away

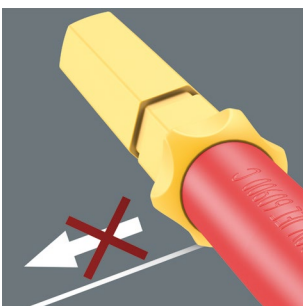

The Kraftform Kompakt blades come with an anti-roll protection. The hexagonal shape hinders the blade from rolling away annoyingly at the workplace.

05006618001		
●	837 i RA	1x 9x115
●	817 VDE	1x 9x98
⊕	Kraftform Kompakt VDE 62 i Take it easy	1x PH 1x157; 1x PH 2x157
⊕	Kraftform Kompakt VDE 65 i Take it easy	1x PZ 1x157; 1x PZ 2x157
⊕	Kraftform Kompakt VDE 65 i PZ/S Take it easy	1x # 1x157; 1x # 2x157
⊕	Kraftform Kompakt VDE 67 i Take it easy	1x TX 10x157; 1x TX 15x157; 1x TX 20x157; 1x TX 25x157
⊖	Kraftform Kompakt VDE 60 i Take it easy	1x 0,4x2,5x157; 1x 0,8x4,0x157; 1x 1,0x5,5x157; 1x 1,2x6,5x157
⊖	Kraftform Kompakt VDE 60 IS Take it easy	1x 0,6x3,5x157

Kraftform Kompakt 838 RA S Set 1

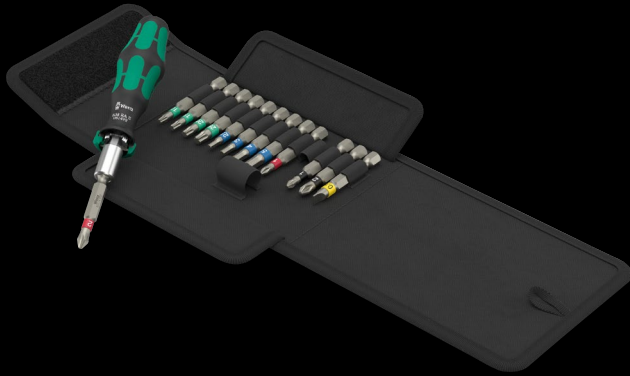

14-piece set

One 838 RA S bitholding handle with ratchet functionality, 13 bits, chemically nickel-plated with "Take it easy" Tool finder: With size stamping and colour coding by output to help you find the required bit easily, 1/4", 50 mm length

05051060001	
●	838 RA S 1x 1/4"x102
⊕	851/4 BTZ 1x PH 1x50; 1x PH 2x50
⊕	855/4 BTZ 1x PZ 1x50; 1x PZ 2x50
⊕	867/4 TORX® BTZ 1x TX 10x50; 1x TX 15x50; 1x TX 20x50; 1x TX 25x50
○	840/4 BTZ 1x 2,5x50; 1x 3,0x50; 1x 4,0x50; 1x 5,0x50
⊖	800/4 BTZ 1x 0,8x5,5x50
	Hook and Loop Fastener Strip 70

Kraftform Kompakt 838 RA-R M Set 1



15-piece set

One 838 RA-R M bitholding handle with ratchet functionality, 14 bits, chemically nickel-plated, 1/4", 89 mm length

05051061001	
●	838 RA-R M 1x 1/4"x123,5
⊕	851/4 Z 1x PH 1x89; 1x PH 2x89; 1x PH 3x89 ¹⁾
⊕	855/4 Z 1x PZ 1x89; 1x PZ 2x89; 1x PZ 3x89 ¹⁾
⊕	867/4 Z TORX® 1x TX 10x89; 1x TX 15x89; 1x TX 20x89; 1x TX 25x89
○	840/4 Z 1x 3,0x89; 1x 4,0x89; 1x 5,0x89
⊖	800/4 Z 1x 1,0x5,5x89
	Hook and Loop Fastener Strip 70

¹⁾ Hexagonal blade

Ratchet functionality



The integrated ratchet with fine toothting (36 teeth) and a return angle of 10° eases and accelerates screwdriving without having to reposition the tool.

Ratchet mechanism in the handle



The integrated ratchet with fine toothting ensures fast and safe working. The ratchet mechanism is completely embedded in the handle. Thanks to the small size of the handle the ratchet can even be used in constricted screwdriving situations.

Rapid screwdriving



The ratchet mechanism also allows fast "spinning" while screwdriving.

Changing ratchet direction



Ergonomic design of the reverse direction switch.



Kraftform Kompakt 20 Tool Finder 1 with pouch



Application: Suitable for 1/4" DIN ISO 1173-C 6.3 and E 6.3 hexagon socket insert bits and Wera Series 1 and 4

Design: Attachment, telescopic, Rapidaptor rapid-in, rapid-out, rapid-spin, chuck-all and single-hand technology; "Take it easy" tool finder: Output colour coding and large stamp to enable the desired bit to be easily located.

Handle: Kraftform with non-roll feature, multi-component, integrated magazine

Telescopic blade, integrated bit magazine, Rapidaptor technology



The sets in the series Kraftform Kompakt 20 are really something. A 2 position telescopic blade can be retracted into the handle for confined space operation or extended for more reach. It can also be removed and used as a 100 mm bit holder in the power tool. Six bits are conveniently integrated

into a push-button opening bit magazine. The Rapidaptor technology ensures rapid one hand bit changes, press-in auto bit lock and a secure positioning when used in power tools thanks to the free-turning sleeve.



The telescopic blade

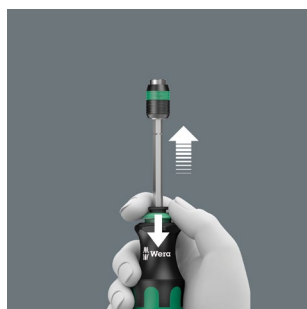

By pushing the clamping sleeve, the telescopic blade can be extended out of the handle and the compact tool becomes a full-sized screwdriver.

05051016001	
⊙	889/4 R 1x 1/4"x100
+	851/1 BTZ 1x PH 1x25; 1x PH 2x25
+	855/1 BTZ 1x PZ 1x25; 1x PZ 2x25
⊗	867/1 TORX® BTZ 1x TX 25x25
⊖	800/1 BTZ 1x 0,8x5,5x25
	Hook and Loop Fastener Strip 70 1x 50,0x70,0

Kraftform Kompakt 60

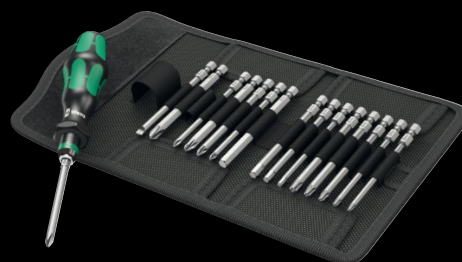

Pouch with 89 mm bits

17-piece set

1 Kraftform bitholding screwdriver 816 R with Rapidaptor quick-release chuck

05059295001	
⊙	816 R 1x 1/4"x119
+	851/4 Z 1x PH 1x89; 1x PH 2x89; 1x PH 3x89 ¹⁾
+	855/4 Z 1x PZ 1x89; 1x PZ 2x89; 1x PZ 3x89 ¹⁾
⊗	867/4 Z 1x TX 10x89; 1x TX 15x89; 1x TX 20x89; TORX® BO 1x TX 25x89; 1x TX 30x89
⊖	800/4 Z 1x 1,0x5,5x89
⊙	840/4 Z 1x 3,0x89; 1x 4,0x89; 1x 5,0x89; 1x 6,0x89 ¹⁾
	Hook and Loop Fastener Strip 70 1x 50,0x70,0

¹⁾ Hexagonal blade

Kraftform Kompakt 400 RA Set 1



17-piece set

Textile box with one 416 RA T-handle bitholding screwdriver with ratchet function and Rapidaptor quick-release chuck, 16 tough bits, 1/4", 89 mm length

05023471001		
⊙	416 RA	1x 1/4"x45
⊕	851/4 Z	1x PH 2x89; 1x PH 3x89 ¹⁾
⊕	855/4 Z	1x PZ 2x89; 1x PZ 3x89 ¹⁾
⊗	867/4 Z	1x TX 10x89; 1x TX 15x89; 1x TX 20x89; 1x TX 25x89; 1x TX 30x89; 1x TX 40x89
⊙	840/4 Z	1x 3,0x89; 1x 4,0x89; 1x 5,0x89; 1x 6,0x89 ¹⁾ ; 1x 8,0x89 ¹⁾
⊖	800/4 Z	1x 1,0x5,5x89
	Hook and Loop Fastener Strip 120	1x 50,0x120,0

¹⁾ Hexagonal blade

Kraftform Kompakt 27 XL Universal 1



Application: Suitable for bits with 1/4" external hexagon drive as per DIN ISO 1173-C 6.3 and E 6.3 and Wera connection series 1 and 4

Design: 300 mm long rigid blade; with compact stainless steel holder and strong permanent magnet. Secure bitholding function thanks to locking mechanism.

Handle: Kraftform with anti-roll protection, multi-component, integrated bit magazine

05051028001		
⊕	851/1 BTZ	1x PH 1x25; 1x PH 2x25
⊕	855/1 BTZ	1x PZ 2x25
⊗	867/1 TORX® BTZ	1x TX 15x25; 1x TX 20x25; 1x TX 25x25
⊙	394 S	1x 1/4"x300

Ratchet mechanism in the handle

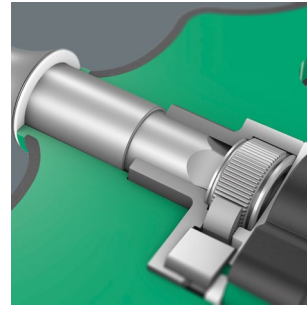

The ratchet mechanism of the 416 RA T-handle bitholding screwdriver is completely embedded in the handle. The compact shape of the tool allows convenient working.

Reversible clockwise/counterclockwise

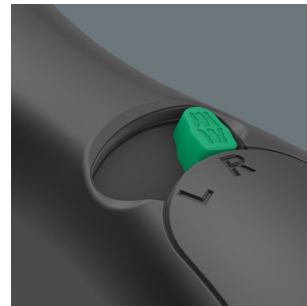

The change of direction can easily be made using the reversing lever.

Fast-rotating sleeve

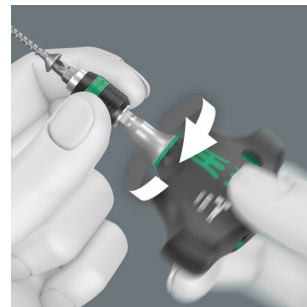

The fast-rotating sleeve allows the tool to be guided safely while screwdriving and increases the working speed.

Handle/interchangeable blade system



The handle/interchangeable blade system allows rapid exchange of the blades required for a wide range of applications.

Kraftform Kompakt VDE 18 Universal 1 Tool finder



18-piece set

One Kraftform 817 VDE bladeholding screwdriver solely for Wera VDE blades
12 VDE blades (each 157 mm length) with "Take it easy" Tool finder with colour coding by profile and laser-engraved size indication, 4 control cabinet keys, one single-pole phase tester

In a robust belt pouch

05006613001	
●	817 VDE 1x 9x98
+	Kraftform 1x PH 1x157; 1x PH 2x157 Kompakt VDE 62 i Take it easy
+	Kraftform 1x PZ 1x157; 1x PZ 2x157 Kompakt VDE 65 i Take it easy
+	Kraftform 1x # 1x157; 1x # 2x157 Kompakt VDE 62 i PH/S Take it easy
+	Kraftform 1x # 1x157; 1x # 2x157 Kompakt VDE 65 i PZ/S Take it easy
●	Kraftform 1x 0,4x2,5x157; 1x 0,6x3,5x157; Kompakt VDE 1x 0,8x4,0x157; 1x 1,0x5,5x157 60 i Take it easy
●	Kraftform 1x 6,3x89 Kompakt VDE VK 6,3
●	Kraftform 1x 8,1x89 Kompakt VDE VK 8,1
▲	Kraftform 1x 89 Kompakt VDE 98 DK
●	Kraftform 1x 89 Kompakt VDE 99 FL
●	247 1x 0,5x3,0x70
	Hook and Loop Fastener Strip 70 1x 50,0x70,0

Product not available in the USA and Canada.

Kraftform Kompakt VDE 7 extra slim 1 Tool finder



7-piece set

One 817 VDE Kraftform bladeholding screwdriver solely for Wera VDE blades

6 VDE blades (each 157 mm length) with "Take it easy" Tool finder with colour coding by profile and laser-engraved size indication; with reduced blade diameter and integrated protective insulation, low-lying screw and spring elements can be easily reached and operated

In a robust belt pouch

05006603001	
●	817 VDE 1x 9x98
+	Kraftform 1x PH 1x157; 1x PH 2x157 Kompakt VDE 62 iS Take it easy
+	Kraftform 1x # 2x157 Kompakt VDE 65 iS PZ/S Take it easy
+	Kraftform 1x TX 15x157; 1x TX 20x157 Kompakt VDE 67 iS Take it easy
●	Kraftform 1x 0,6x3,5x157 Kompakt VDE 60 iS Take it easy
	Hook and Loop Fastener Strip 70 1x 50,0x70,0

Easy change

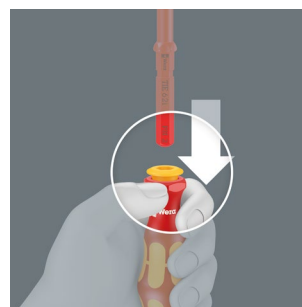

The Kraftform Kompakt VDE blades can be replaced simply by pulling down the yellow ring on the handle.

Kraftform Kompakt VDE 16 Torque 1.2-3.0 Nm extra slim 1 Tool finder

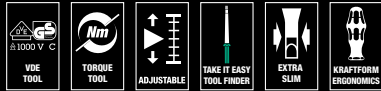

16-piece set

One series 7400 VDE Kraftform adjustable torque bladeholding screwdriver (1.2 - 3.0 Nm) and one 817 VDE bitholding screwdriver; solely for Wera VDE blades

14 VDE blades (each 157 mm length) with "Take it easy" Tool finder with colour coding by profile and laser-engraved size indication; with reduced blade diameter (items Kraftform Kompakt 60 i Take it easy 0.4x2.5 and Kraftform Kompakt 67 i Take it easy TX 10 standard blade diameter) with integrated protective insulation, low-lying screw and spring elements can be easily reached and operated

In a robust belt pouch

05006609001		
●	7400 VDE	1x 7441 VDE, 1,2-3,0 Nm
●	817 VDE	1x 9x98
+	Kraftform Kompakt VDE 62 iS Take it easy	1x PH 1x157; 1x PH 2x157
+	Kraftform Kompakt VDE 65 iS Take it easy	1x PZ 1x157; 1x PZ 2x157
+	Kraftform Kompakt VDE 65 iS PZ/S Take it easy	1x # 1x157; 1x # 2x157
⊗	Kraftform Kompakt VDE 67 i Take it easy	1x TX 10x157
⊗	Kraftform Kompakt VDE 67 iS Take it easy	1x TX 15x157; 1x TX 20x157; 1x TX 25x157
⊖	Kraftform Kompakt VDE 60 i Take it easy	1x 0,4x2,5x157
⊖	Kraftform Kompakt VDE 60 iS Take it easy	1x 0,6x3,5x157; 1x 0,8x4,0x157; 1x 1,0x5,5x157
	Hook and Loop Fastener Strip 70	1x 50,0x70,0



Kraftform adjustable torque handle for Electricians

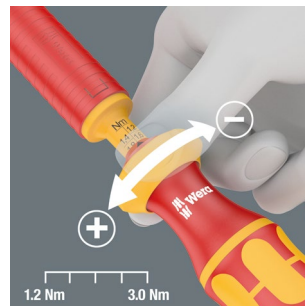

Simple setting of the required torque by hand.



Excess-load signal

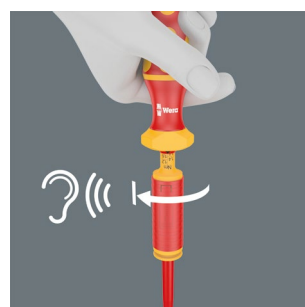

Distinctly audible and noticeable excess-load signal when the pre-set torque is reached.

Kraftform Kompakt VDE 17 Universal 1 Tool finder



17-piece set

2 Kraftform 817 VDE bitholding screwdrivers solely for Wera VDE blades

15 VDE blades (each 157 mm length) with "Take it easy" Tool finder: Colour coding by profile and laser-engraved size indication

In a robust belt pouch

Kraftform Kompakt VDE Big Pack 1

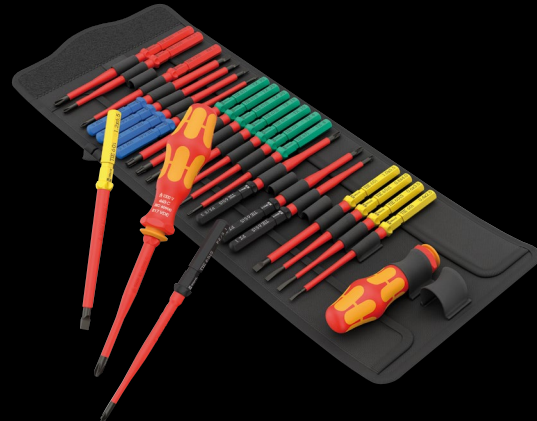

26-piece set

2 Kraftform 817 VDE blade-holding screwdrivers solely for Wera VDE blades

24 VDE blades (each 157 mm length) with "Take it easy" Tool finder with colour coding by profile and laser-engraved size indication

Robust textile roll pouch

05006611001	
●	817 VDE 2x 9x98
+	Kraftform Kompakt VDE 62 i Take it easy 1x PH 1x157; 1x PH 2x157
+	Kraftform Kompakt VDE 65 i Take it easy 1x PZ 1x157; 1x PZ 2x157
+	Kraftform Kompakt VDE 65 i PZ/S Take it easy 1x # 1x157; 1x # 2x157
+	Kraftform Kompakt VDE 67 i Take it easy 1x TX 10x157; 1x TX 15x157; 1x TX 20x157; 1x TX 25x157
●	Kraftform Kompakt VDE 60 i Take it easy 1x 0,4x2,5x157; 1x 0,8x4,0x157; 1x 1,0x5,5x157; 1x 1,2x6,5x157
●	Kraftform Kompakt VDE 60 iS Take it easy 1x 0,6x3,5x157
	Hook and Loop Fastener Strip 70 1x 50,0x70,0

05006617001	
●	817 VDE 2x 9x98
+	Kraftform Kompakt VDE 62 iS Take it easy 1x PH 1x157; 1x PH 2x157
+	Kraftform Kompakt VDE 65 iS Take it easy 1x PZ 1x157; 1x PZ 2x157
+	Kraftform Kompakt VDE 62 iS PH/S Take it easy 1x # 1x157; 1x # 2x157
+	Kraftform Kompakt VDE 65 iS PZ/S Take it easy 1x # 1x157; 1x # 2x157
+	Kraftform Kompakt VDE 67 i Take it easy 1x TX 8x157; 1x TX 9x157; 1x TX 10x157; 1x TX 30x157
+	Kraftform Kompakt VDE 67 iS Take it easy 1x TX 15x157; 1x TX 20x157; 1x TX 25x157
○	Kraftform Kompakt VDE 64 i Take it easy 1x 2,5x157; 1x 3,0x157; 1x 4,0x157; 1x 5,0x157
●	Kraftform Kompakt VDE 60 i Take it easy 1x 0,4x2,5x157; 1x 1,2x6,5x157
●	Kraftform Kompakt VDE 60 iS Take it easy 1x 0,6x3,5x157; 1x 0,8x4,0x157; 1x 1,0x5,5x157





Individually tested



Each Kraftform Kompakt VDE set has been tested individually at 10,000 volts, in accordance with IEC 60900. This ten-times-higher testing load guarantees safe working at their maximum permitted load of 1,000 volts.

Handle/interchangeable blade system

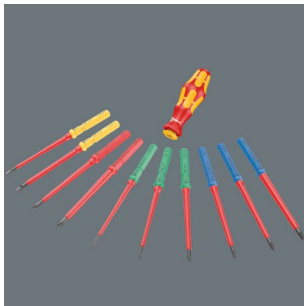

The handle/interchangeable blade system allows rapid exchange of the blades required for a wide range of applications.

Kraftform Kompakt VDE 17 extra slim 1 Tool finder



17-piece set

2x 817 VDE bitholding screwdrivers; solely for Wera VDE blades

14 VDE blades (each 157 mm length) with reduced blade diameter (items Kraftform Kompakt 60 i Take it easy 0.4x2.5 and Kraftform Kompakt 67 i TX 10 standard blade diameter) with integrated protective insulation, low-lying screw and spring elements can be easily reached and operated. With "Take it easy" Tool finder with colour coding by profile and laser-engraved size indication.

1x Knipex VDE 13 96 200 pliers for electrical installation; for cutting, stripping, gripping, bending, deburring and crimping. With safety pawl for gentle gripping. Chrome-plated for better rust protection, with insulated multi-component handle sleeves.



05006612001		
●	817 VDE	2x 9x98
+	Kraftform Kompakt VDE 62 iS Take it easy	1x PH 1x157; 1x PH 2x157
+	Kraftform Kompakt VDE 65 iS Take it easy	1x PZ 1x157; 1x PZ 2x157
+	Kraftform Kompakt VDE 65 iS PZ/S Take it easy	1x # 1x157; 1x # 2x157
+	Kraftform Kompakt VDE 67 i Take it easy	1x TX 10x157
+	Kraftform Kompakt VDE 67 iS Take it easy	1x TX 15x157; 1x TX 20x157; 1x TX 25x157
+	Kraftform Kompakt VDE 60 i Take it easy	1x 0,4x2,5x157
+	Kraftform Kompakt VDE 60 iS Take it easy	1x 0,6x3,5x157; 1x 0,8x4,0x157; 1x 1,0x5,5x157
KNIPEX VDE 13 96 200 pliers for electrical installation		
Hook and Loop Fastener Strip 70		1x 50,0x70,0



Wera 2go 1 Tool Carrier



1 tool carrier with hook and loop fastener system for the attachment of other Wera 2go components as well as Wera textile boxes and pouches with hook and loop fastener zones; 1 shoulder strap with adjustable-width padding, adjustable in length, detachable.

	
05004350001	
Wera 2go 5	1x 135,0x300,0x270,0
Wera 2go 6	1x 38,0x1470,0

Wera 2go 2 Tool Container



1 dimensionally stable, robust Tool Container with hook and loop fastener system for the attachment of other Wera 2go components as well as Wera textile boxes and pouches with hook and loop fastener zones; high resistance against cuts and stabs; 1 handle and 1 Shoulder Strap with adjustable-width padding, adjustable in length, detachable; 1 removable Tool Quiver with handle and a variable hook and loop fastener partition for a division into as many as 5 inner sections.

05004351001	
Wera 2go Container	1x 355,0x330,0x115,0
Wera 2go 6	1x 38,0x1470,0
Wera 2go 4	1x 165,0x165,0x105,0

Wera 2go 2 XL Tool Container



1 dimensionally stable, robust Tool Container for up to four Wera 2 go 4 Tool Quivers; with hook and loop fastener system for the attachment of other Wera 2go components as well as Wera textile boxes and pouches with hook and loop fastener zones; high resistance against cuts and stabs; 1 handle and 1 Shoulder Strap with adjustable-width padding, adjustable in length, detachable; 1 removable Tool Quiver with handle

05004357001	
	Wera 2go XL 1x 455,0x330,0x170,0 Container
	Wera 2go 6 1x 38,0x1470,0
	Wera 2go 4 1x 165,0x165,0x105,0

Wera 2go 3 Tool Box



1 dimensionally stable and robust Tool Box, empty, equipped with handle for the storage and transport of tools and small parts; high resistance against cuts and stabs; comes with hook and loop fastener zone for docking with the Wera 2go system.

	mm	mm	mm
05004352001	130,0	325,0	80,0

Wera 2go 7 High Tool Box



1 sturdy, robust High Tool Box, with carrying handle, for storage and transport of long tools and spare parts. High resistance against cuts and stabs. With hook and loop fastener zones for docking onto the Wera 2go system.

	mm	mm	mm
05004356001	295,0	100,0	100,0

Variable thanks to the hook and loop fastener system



The hook and loop fastener system means that other Wera 2go system components can be just as easily attached to the Wera 2go 1 Tool Carrier as all other Wera tools in boxes and pouches with hook and loop fastener zones. This enables an individual composition of the tools needed for a specific job.



Which textile boxes can be docked with the Wera 2go system without the need for any additional aids?



Wera packaging bearing this symbol contains tool pouches or textile boxes with nonwoven sections that can be docked with the Wera 2go system.



Zyklop Speed

The “original” Zyklop is particularly impressive because it combines 5 types of ratchet into a single tool, and delivers the fastest working speeds. Both features result in making work simpler, and saving time. So with this in mind, the original Zyklop will be known as the Zyklop Speed from now on.



Zyklop Pocket

Compact Zyklop ratchet with bit magazine for the pocket. Magnetic direct mounting for 1/4" bits and 3/8" sockets. Rapid tool change thanks to the non-locking mounting. As the head is lockable at 0°, 15° and 90°, the tool can be used as a ratchet and as a ratchet screwdriver.



Zyklop VDE

We want users of our tools to work safely and comfortably. The Zyklop VDE ratchet and accessories are the right tools for safe working on electrical systems, with features that will impress, even in tight conditions.



Zyklop Comfort

Compelling Wera style Zyklop Comfort ratchet with reversing lever. Comfortable 2-component plastic sleeve. Protects sensitive surfaces. Slim design for working even in very confined spaces. The fine toothing with 80 teeth allows for a low return angle of only 4.5°.



Zyklop Hybrid Zyklop Metal

We wanted to combine the most-requested advantages of a ratchet in a single tool. Our idea was to develop a light-weight ratchet with an ergonomic Kraftform handle, a slim head design, a long lever and an extension option. Introducing... Zyklop Hybrid.

The Zyklop Metal ratchets are made completely of metal (chrome-molybdenum), so they will be referred to as Zyklop Metal. The new branch of the family will include the Zyklop Metal with a "push-through" square drive and the Zyklop Metal with switch lever.

Zyklop Mini

Filigree design combined with incredible robustness – this is an industrial-strength tool. The Zyklop Mini is used whenever there is insufficient space to work with a power tool or conventional hand tools.

Koloss

The ratchet that can also safely and officially be used as a hammer! The Koloss is a reversible, heavy-duty ratchet that can be used with a load of at least 600 Newton meters.

8007 B VDE Zyklop ratchet, insulated, with switch lever, with 3/8" drive



Application: 3/8" square sockets as well as for 3/8" adaptors with square drive, with ball locking device

Design: Individually tested as per IEC 60900 at 10,000V for safe working at the approved voltage of 1,000V; slim design to enable work in very confined spaces; fine-tooth mechanism with 80 teeth for a return angle of only 4.5°; switch lever for convenient change of direction; secure socket locking function by push button

		mm
05004966001	3/8"	222,0

Belt B VDE 1 Zyklop bit socket set TORX® / hexagonal socket with holding function, 3/8" drive



10-piece; robust textile socket belt, including snap hook to enable secure fastening to a belt loop or pocket. Non-woven reverse side and hook and loop strips for simple attachment e.g. to a wall, shelf, tool trolley and to the Wera 2go tool transport system. Fast and easy Twist to Unlock mechanism for secure storage and simple removal of the tool sockets.

10 Zyklop bit sockets, with 3/8" drive. Insulated, individually tested as per IEC 60900. Increased safety due to 2-component insulation with yellow insulation core, which becomes visible in case of damage to the outer red VDE insulation layer. With holding function for TORX® screws made according to Acument Intellectual Properties specifications and hexagonal socket screws. Short bit sockets with the benefits of the Wera bit technology.

05004930001		
	8767 B VDE HF	1x TX 20x55,0; 1x TX 25x55,0; 1x TX 27x55,0; 1x TX 30x55,0; 1x TX 40x55,0; 1x TX 45x59,0
	8740 B VDE HF	1x 4,0x55,0; 1x 5,0x55,0; 1x 6,0x55,0; 1x 8,0x59,0
	Belt B VDE 0/10	1x 71,0x209,0
	Hook and Loop Fastener Strip 30	1x 30,0x200,0

8100 SB VDE 1 Zyklop Ratchet set, insulated, switch lever, 3/8" drive, metric



17 pieces; in a surface-preserving, compact and extremely robust textile box; low volume and weight for simplified mobility. Fleece backing and hook and loop fastener system for easy attachment, e. g. on wall, shelf, workshop trolley and the Wera 2go tool transport system. Smooth rotating mechanism for safe storage and easy removal of the Zyklop VDE sockets.

1 Zyklop Ratchet 8007 B VDE, with switch lever, with 3/8" drive, 14 Zyklop VDE sockets, 2 Zyklop VDE extensions, one long, one short, all tools insulated, individually tested as per IEC 60900 at 10,000 V for safe working at the approved voltage of 1,000 V. The Zyklop VDE sockets and extensions offer increased safety through 2-component isolation with yellow insulation core, which becomes visible in case of damage to the outer red VDE insulation layer.

05004970001		
	8007 B VDE	1x 3/8"x222,0
	8790 B VDE	1x 6,0x46,0; 1x 7,0x46,0; 1x 8,0x46,0; 1x 9,0x46,0; 1x 10,0x46,0; 1x 11,0x46,0; 1x 12,0x46,0; 1x 13,0x46,0; 1x 14,0x46,0; 1x 15,0x46,0; 1x 16,0x46,0; 1x 17,0x46,0; 1x 18,0x46,0; 1x 19,0x46,0
	8794 SB VDE	1x 3/8"x91,0
	8794 LB VDE	1x 3/8"x166,0
	Hook and Loop Fastener Strip 240	1x 50,0x240,0

Increased safety

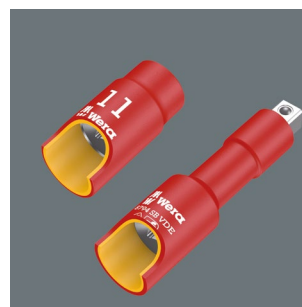

The Zyklop sockets and extensions for electricians offer increased safety thanks to their 2-component isolation with yellow insulation core under red insulation outer layer.

8100 SB 12 Zyklop Comfort Ratchet set, reversing lever, 3/8" drive, metric



16-piece set; in surface-friendly, compact and extremely robust textile box. Small size and low weight for better mobility.

1 Zyklop Comfort ratchet with reversing lever with 3/8" drive, 14 Zyklop Impaktor sockets, 1 Zyklop extension



05005530001		
○	8010 B	1x 3/8"x230,0
●	8790 B Impaktor	1x 8,0x30,0; 1x 10,0x30,0; 1x 11,0x30,0; 1x 12,0x30,0; 1x 13,0x30,0; 1x 14,0x30,0; 1x 15,0x30,0; 1x 16,0x30,0; 1x 17,0x30,0; 1x 18,0x30,0; 1x 19,0x30,0; 1x 21,0x32,0; 1x 22,0x32,0
●○	8798 B	1x 3/8"x152,4

9607 Magnetic rail B Impaktor 1

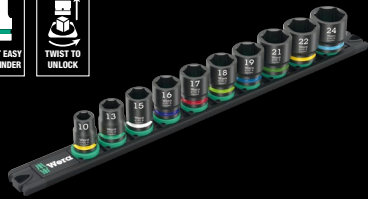

10-piece set; on a magnetic rail for temporary attachment on wall, shelf or workshop trolley. Smooth rotary mechanism for safe storage and easy access of the tools.

10 Impaktor sockets with 3/8" drive. With hexagon profile and socket with hole. For use with electric or pneumatic wrenches with 3/8" drive. "Take it easy" Tool finder: With colour coding by size - for quick and easy identification of the required tool.

05005451001		
●	8790 B Impaktor	1x 10,0x30,0; 1x 13,0x30,0; 1x 15,0x30,0; 1x 16,0x30,0; 1x 17,0x30,0; 1x 18,0x30,0; 1x 19,0x30,0; 1x 21,0x32,0; 1x 22,0x32,0; 1x 24,0x32,0
	9603	1x 30,0x340,0



For electric or pneumatic impact wrenches



The Impaktor technology ensures above-average service life of the Impaktor socket wrench plug-ins even under extreme conditions.

8000 A Zyklop Speed Ratchet with 1/4" drive



Application: 1/4" square sockets and 1/4" adaptors with square drive, equipped with ball lock

Design: Flywheel design and easy-to-grip free-turning sleeve for faster work, swivel ratchet head, defined lock positions at 0° and 90° to the left and right as well as at 15° before 90° inwards, at 0° it can be used like a conventional screwdriver, pushbutton release, left/right switchover, fine-tooth design, small return angle of 5°

Handle: Multi-component Kraftform handle ensures minimum fatigue

05073260001		
○	1/4"	152.0

8000 B Zyklop Speed Ratchet with 3/8" drive

05073261001		
○	3/8"	199.0

8000 C Zyklop Speed Ratchet with 1/2" drive

05073262001		
○	1/2"	277.0

8100 SA 6 Zyklop Speed Ratchet Set, 1/4" drive, metric



28-piece set; in a surface-preserving, compact and extremely robust textile box; low volume and weight for simplified mobility

1 Zyklop Speed Ratchet with 1/4" drive, 9 Zyklop sockets, 1 Zyklop extension (long) with free-turning sleeve, 1 wobble extension, 1 adaptor with quick-release chuck, 15 bits

05004016001		
□	8000 A	1x 1/4"x152,0
●	8790 HMA	1x 5,0x23,0; 1x 5,5x23,0; 1x 6,0x23,0; 1x 7,0x23,0; 1x 8,0x23,0; 1x 10,0x23,0; 1x 11,0x23,0; 1x 12,0x23,0; 1x 13,0x23,0
◐◐	8794 LA	1x 1/4"x150,0
◐◑	8794 A	1x 1/4"x56,0
◑◑	8784 A1	1x 1/4"x1/4"x37,0
+	851/4 TZ	1x PH 1x50; 1x PH 2x50; 1x PH 3x50
+	855/4 TZ	1x PZ 1x50; 1x PZ 2x50
⊗	867/4 Z TORX®	1x TX 10x50; 1x TX 15x50; 1x TX 20x50; 1x TX 25x50; 1x TX 27x50; 1x TX 30x50
○	840/4 Z	1x 3,0x50; 1x 4,0x50; 1x 5,0x50; 1x 6,0x50 ¹⁾
	Hook and Loop Fastener Strip 120	1x 50,0x120,0

¹⁾ Hexagonal blade

8100 SB 6 Zyklop Speed Ratchet Set, 3/8" drive, metric



29-piece set; in a surface-preserving, compact and extremely robust textile box; low volume and weight for simplified mobility

1 Zyklop Speed Ratchet with 3/8" drive, 9 Zyklop sockets, 1 Zyklop extension (long) with free-turning sleeve, 1 wobble extension, 1 adaptor with quick-release chuck, 16 bits

05004046001		
□	8000 B	1x 3/8"x199,0
●	8790 HMB	1x 8,0x29,0; 1x 10,0x29,0; 1x 12,0x29,0; 1x 13,0x29,0; 1x 15,0x29,0; 1x 16,0x30,0; 1x 17,0x30,0; 1x 18,0x30,0; 1x 19,0x30,0
◐◐	8794 LB	1x 3/8"x200,0
◐◑	8794 B	1x 3/8"x76,0
◑◑	8784 B1	1x 1/4"x3/8"x44,0
+	851/4 TZ	1x PH 1x50; 1x PH 2x50; 1x PH 3x50
+	855/4 TZ	1x PZ 1x50; 1x PZ 2x50; 1x PZ 3x50
⊗	867/4 Z TORX®	1x TX 20x50; 1x TX 25x50; 1x TX 27x50; 1x TX 30x50; 1x TX 40x50
○	840/4 Z	1x 4,0x50; 1x 5,0x50; 1x 6,0x50 ¹⁾ ; 1x 8,0x50 ¹⁾
◐	800/4 Z	1x 1,0x5,5x50

¹⁾ Hexagonal blade

8100 SC 6 Zyklop Speed Ratchet Set, 1/2" drive, metric



28-piece set; in a surface-preserving, compact and extremely robust textile box; low volume and weight for simplified mobility

1 Zyklop Speed Ratchet with 1/2" drive, 10 Zyklop sockets, 1 Zyklop extension (long) with free-turning sleeve, 1 wobble extension, 1 adaptor with quick-release chuck, 14 bits

05004076001		
□	8000 C	1x 1/2"x277,0
●	8790 HMC	1x 10,0x37,0; 1x 11,0x37,0; 1x 12,0x37,0; 1x 13,0x37,0; 1x 14,0x37,0; 1x 15,0x37,0; 1x 16,0x37,0; 1x 17,0x37,0; 1x 18,0x37,0; 1x 19,0x37,0
◐◐	8794 LC	1x 1/2"x250,0
◐◑	8794 C	1x 1/2"x52,0
◑◑	8784 C2	1x 5/16"x1/2"x50,0
+	851/2 Z	1x PH 2x32; 1x PH 3x32
+	855/2 Z	1x PZ 2x32; 1x PZ 3x32
⊗	867/2 Z TORX®	1x TX 20x35; 1x TX 25x35; 1x TX 30x35; 1x TX 40x35; 1x TX 45x35; 1x TX 50x35
○	840/2 Z	1x 5x30; 1x 6x30; 1x 8x30; 1x 10x30

8100 SA All-in Zyklop Speed Ratchet Set, 1/4" drive, with holding function, metric



42-piece set; in a surface-preserving, compact and extremely robust textile box; low volume and weight for simplified mobility. Non-woven reverse side and hook and loop strips for simple attachment e.g. to a wall, shelf, tool trolley and to the Wera 2go tool transport system. Fast and easy Twist to Unlock mechanism for secure storage and simple removal of the sockets.

1 Zyklop Speed Ratchet with 1/4" drive, 13 Zyklop sockets with 1/4" drive with fastener holding function, 9 Zyklop bit sockets for TORX® screws, with 1/4" drive, with holding function, 8 bit sockets for hexagon socket screws with 1/4" drive with holding function (sizes 2.0 and 2.5 without holding function) and Hex-Plus high torque geometry, 3 Zyklop bit sockets with 1/4" drive for Phillips screws, 3 Zyklop bit sockets with 1/4" drive for Pozidriv screws, 2 Zyklop bit sockets with 1/4" drive for slotted screws, "Take it easy" tool finder: Colour coding to enable the desired bit socket to be easily selected, 1 tool for the simple removal of nuts from sockets with holding function, 1 Zyklop extension (long) with free-turning sleeve, 1 wobble extension.

05003755001		
○	8000 A	1x 1/4"x152,0
⊗	8796 LA	1x 1/4"x150,0
⊗	8794 A	1x 1/4"x56,0
⊙	8790 HMA HF	1x 4,0x23,0; 1x 4,5x23,0; 1x 5,0x23,0; 1x 5,5x23,0; 1x 6,0x23,0; 1x 7,0x23,0; 1x 8,0x23,0; 1x 9,0x23,0; 1x 10,0x23,0; 1x 11,0x23,0; 1x 12,0x23,0; 1x 13,0x23,0; 1x 14,0x23,0
⊕	8767 A HF	1x TX 8x28,0; 1x TX 9x28,0; 1x TX 10x28,0; 1x TX 15x28,0; 1x TX 20x28,0; 1x TX 25x28,0; 1x TX 27x28,0; 1x TX 30x28,0; 1x TX 40x28,0
○	8740 A	1x 2,0x28,0; 1x 2,5x28,0
○	8740 A HF	1x 3,0x28,0; 1x 4,0x28,0; 1x 5,0x28,0; 1x 6,0x28,0; 1x 7,0x28,0; 1x 8,0x28,0
⊕	8751 A	1x PH 1x28,0; 1x PH 2x28,0; 1x PH 3x28,0
⊕	8755 A	1x PZ 1x28,0; 1x PZ 2x28,0; 1x PZ 3x28,0
⊖	8700 A FL	1x 0,8x5,5x28,0; 1x 1,2x6,5x28,0
	Nut Extractor	1x 14,0x43,0
	Hook and Loop Fastener Strip 120	1x 50,0x120,0

8100 SB All-in Zyklop Speed ratchet set, 3/8" drive



35-piece set; in surface-friendly, compact and extremely robust textile box. Small size and low weight for better mobility.

1 Zyklop Speed ratchet with 3/8" drive, 14 Zyklop sockets with holding function for external hexagon screws, 9 Zyklop bit sockets with holding function for TORX® socket screws, 8 Zyklop bit sockets with holding function for hexagonal socket screws, 1 Zyklop extension "flexible-lock" with fast-rotating sleeve, long, 1 Zyklop-"Wobble" extension, 1 tool for bolt removal

05003536001		
○	8000 B	1x 3/8"x199,0
⊗	8794 B	1x 3/8"x76,0
⊗	8796 LB	1x 3/8"x200,0
⊙	8790 HMB HF	1x 6,0x29,0; 1x 7,0x29,0; 1x 8,0x29,0; 1x 9,0x29,0; 1x 10,0x29,0; 1x 11,0x29,0; 1x 12,0x29,0; 1x 13,0x29,0; 1x 14,0x29,0; 1x 15,0x29,0; 1x 16,0x29,0; 1x 17,0x29,0; 1x 18,0x29,0; 1x 19,0x29,0
⊕	8767 B HF	1x TX 10x35,0; 1x TX 15x35,0; 1x TX 20x35,0; 1x TX 25x35,0; 1x TX 27x35,0; 1x TX 30x35,0; 1x TX 40x35,0; 1x TX 45x38,5; 1x TX 50x38,5
○	8740 B HF	1x 3,0x35,0; 1x 4,0x35,0; 1x 5,0x35,0; 1x 6,0x35,0; 1x 7,0x38,5; 1x 8,0x38,5; 1x 9,0x38,5; 1x 10,0x38,5
	Nut Extractor	1x 14,0x43,0
	Hook and Loop Fastener Strip 240	1x 50,0x240,0

Zyklop "6 in 1"



1. Fine-tooth ratchet 2. Flex-head ratchet 3. Angle ratchet 4. Quick-release ratchet 5. Power ratchet 6. Screwdriver

8009 Zyklop Pocket Set 1



13-piece set; 1 Zyklop Pocket 8009 for $\frac{3}{8}$ " sockets as well as $\frac{3}{8}$ " connectors with square head drive; also suitable for bits with $\frac{1}{4}$ " external hexagon drive as per DIN ISO 1173-C 6.3 and E 6.3 and Wera connection series 1 and 4. $\frac{3}{8}$ " ratchet and $\frac{1}{4}$ " bit ratchet screwdriver; freely swivelling ratchet head; pre-defined positions at 0°, 15° and 90° to the left and right; can be used as a conventional screwdriver in the 0° position; clockwise/counterclockwise switching, fine-toothed, small return angle of 5°; magnetic direct mounting. Multi-component Kraftform handle for fatigue-free working; captive, freely swivelling magazine with 12 bits integrated in the handle, $\frac{1}{4}$ ", 25 mm length.

05004280001	
8009	1x $\frac{3}{8}$ "x $\frac{1}{4}$ "x133,0
851/1 BTZ	1x PH 1x25; 1x PH 2x25
855/1 BTZ	1x PZ 1x25; 1x PZ 2x25
867/1 TORX® BTZ	1x TX 10x25; 1x TX 15x25; 1x TX 20x25; 1x TX 25x25
840/1 BTZ	1x 3,0x25; 1x 4,0x25; 1x 5,0x25; 1x 6,0x25

8009 Zyklop Pocket Set 2



18-piece set; 1 Zyklop Pocket 8009 for $\frac{3}{8}$ " sockets as well as $\frac{3}{8}$ " connectors with square head drive; also suitable for bits with $\frac{1}{4}$ " external hexagon drive as per DIN ISO 1173-C 6.3 and E 6.3 and Wera connection series 1 and 4. $\frac{3}{8}$ " ratchet and $\frac{1}{4}$ " bit ratchet screwdriver; freely swivelling ratchet head; pre-defined positions at 0°, 15° and 90° to the left and right; can be used as a conventional screwdriver in the 0° position; clockwise/counterclockwise switching, fine-toothed, small return angle of 5°; magnetic direct mounting. Multi-component Kraftform handle for fatigue-free working; captive, freely swivelling magazine with 12 bits integrated in the handle, $\frac{1}{4}$ ", 25 mm length; one universal holder (75 mm length) with stainless steel sleeve and strong permanent magnet, suitable for mounting bits with $\frac{1}{4}$ " external hexagon drive as per DIN ISO 1173-C 6.3 and Wera connection series 1; 3 Zyklop sockets, $\frac{3}{8}$ "; one robust textile tool holster 9468, can be attached to the belt and docked onto the Wera 2go system.

05004281001	
8009	1x $\frac{3}{8}$ "x $\frac{1}{4}$ "x133,0
893/1/1	1x $\frac{1}{4}$ "x75
851/1 BTZ	1x PH 1x25; 1x PH 2x25
855/1 BTZ	1x PZ 1x25; 1x PZ 2x25
867/1 TORX® BTZ	1x TX 10x25; 1x TX 15x25; 1x TX 20x25; 1x TX 25x25
840/1 BTZ	1x 3,0x25; 1x 4,0x25; 1x 5,0x25; 1x 6,0x25
8790 HMB	1x 8,0x29,0; 1x 10,0x29,0; 1x 13,0x29,0
9468	1x 155,0x65,0
Hook and Loop Fastener Strip 70	1x 50,0x70,0

8009 Zyklop Pocket Set 3



27-piece set; one Zyklop Pocket 8009 for $\frac{3}{8}$ " square head sockets as well as $\frac{3}{8}$ " connectors with square head drive; also suitable for bits with $\frac{1}{4}$ " external hexagon drive as per DIN ISO 1173-C 6.3 and E 6.3 and Wera connection series 1 and 4. $\frac{3}{8}$ " ratchet and $\frac{1}{4}$ " bit ratchet screwdriver; freely swivelling ratchet head; pre-defined positions at 0°, 15° and 90° to the left and right; can be used as a conventional screwdriver in the 0° position; clockwise/anti-clockwise switching, fine-toothed, small return angle of 5°; magnetic direct mounting. Multi-component Kraftform handle for fatigue-free working; captive, freely swivelling magazine with 12 bits integrated in the handle, $\frac{1}{4}$ ", 25 mm length. One Zyklop extension 8794 SB with fast-rotating sleeve, short; one universal holder (75 mm length) with stainless steel sleeve and strong permanent magnet, suitable for mounting bits with $\frac{1}{4}$ " external hexagon drive as per DIN ISO 1173-C 6.3 and Wera connection series 1; 12 Zyklop sockets, $\frac{3}{8}$ "; one robust textile box, can be docked onto the Wera 2go system.

05004284001	
8009	1x $\frac{3}{8}$ "x $\frac{1}{4}$ "x133,0
8794 SB	1x $\frac{3}{8}$ "x125,0
893/1/1	1x $\frac{1}{4}$ "x75
8790 HMB	1x 6,0x29,0; 1x 7,0x29,0; 1x 8,0x29,0; 1x 9,0x29,0; 1x 10,0x29,0; 1x 11,0x29,0; 1x 12,0x29,0; 1x 13,0x29,0; 1x 14,0x29,0; 1x 15,0x29,0; 1x 16,0x30,0; 1x 17,0x30,0
851/1 BTZ	1x PH 1x25; 1x PH 2x25
855/1 BTZ	1x PZ 1x25; 1x PZ 2x25
867/1 TORX® BTZ	1x TX 10x25; 1x TX 15x25; 1x TX 20x25; 1x TX 25x25
840/1 BTZ	1x 3,0x25; 1x 4,0x25; 1x 5,0x25; 1x 6,0x25
Hook and Loop Fastener Strip 120	1x 50,0x120,0



Combination tool mounting



The magnetic direct mounting is suitable for $\frac{3}{8}$ " sockets as well as $\frac{1}{4}$ " bits without the need for an adapter.

8006 C Zyklop Hybrid Ratchet with switch lever and 1/2" drive



Application: 1/2" square sockets as well as for 1/2" adaptors with square drive, with ball locking device

Design: Fine-tooth mechanism with 72 teeth for a return angle of only 5°; switch lever for convenient change of direction; secure socket locking function

Handle: Multi-component Krafftform handle for optimum pressure and tensile loads, handle end designed for connection of Zyklop Hybrid extension 8797 C

	mm	mm	mm	
05003780001	1/2"	281,0	34	37

8797 C Zyklop Hybrid extension



Application: Extension for use with Wera Zyklop Hybrid 8006 C to increase torque transfer

Design: Tough, tempered Cr-Mo steel

Handle: Multi-component Krafftform handle for optimum pressure and tensile loads; with extension release pin

	mm	mm
05003781001	271,0	134,0

8006 SC 1 Zyklop Hybrid Ratchet Set, 1/2" drive, metric



Higher torque transfer



Larger overall length for higher torque transfer.

Extension to increase torque transfer

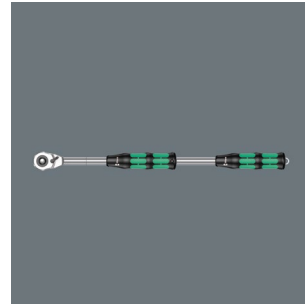

Even more torque can be applied by using the extension.

Ideal for working in confined spaces



Very slim ratchet head.

13-piece set; in a surface-preserving, compact and extremely robust textile box; low volume and weight for simplified mobility

1 Zyklop Hybrid Ratchet with 1/2" drive, 10 Zyklop sockets with holding function, 1 Zyklop Hybrid Extension with release pin, 1 Zyklop extension (long) with free-turning sleeve

05004090001			
	8006 C	1x 1/2"x281,0	
	8797 C	1x 271,0	
	8794 LC	1x 1/2"x250,0	
	8790 HMC HF	1x 10,0x37,0; 1x 11,0x37,0; 1x 12,0x37,0; 1x 13,0x37,0; 1x 14,0x37,0; 1x 15,0x37,0; 1x 16,0x37,0; 1x 17,0x37,0; 1x 18,0x37,0; 1x 19,0x37,0	
	Hook and Loop Fastener Strip 240	1x 50,0x240,0	



Zyklop Metal Push

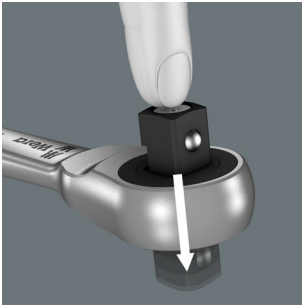

Due to the ever-more confined working environment, space is becoming more and more an issue for the application of ratchets. Our product developers therefore intensively occupied themselves with the issue of confined working spaces, and Wera has now solved this problem. The extremely slim and robust Zyklop Metal ratchet with a long lever was what emerged. When the socket must not get lost and a coincidental change of direction has to be avoided at all cost, the Zyklop Metal Push is the correct choice.



8003 A Zyklop Metal Ratchet with push-through square and 1/4" drive



Application: 1/4" square sockets as well as for 1/4" adaptors with square drive, with ball locking device

Design: Forged, full metal ratchet (chrome-molybdenum) that is extremely robust with a long service life; slim design to enable work in very confined spaces; the dual-ratchet-teeth design means that a 76 fine-toothing division can be achieved from the 38 robust teeth with a return angle of only 4.7°; simple direction change with the undetachable push-through square and very secure socket lock mechanism

	mm	mm	mm	mm
05004003001	1/4"	141	21	22

8003 B Zyklop Metal Ratchet with push-through square and 3/8" drive

	mm	mm	mm	mm
05004033001	3/8"	222,0	27	29

8003 C Zyklop Metal Ratchet with push-through square and 1/2" drive

	mm	mm	mm	mm
05004063001	1/2"	281	36	37

8100 SA 7 Zyklop Metal Ratchet Set with push-through square, 1/4" drive, metric



28-piece set; in a surface-preserving, compact and extremely robust textile box; low volume and weight for simplified mobility

1 Zyklop Metal Ratchet with push-through square and 1/4" drive, 9 Zyklop sockets, 1 Zyklop extension (long) with free-turning sleeve, 1 wobble extension, 1 adaptor with quick-release chuck, 15 bits

05004017001			
	8003 A	1x 1/4"x141	
	8790 HMA	1x 5,0x23,0; 1x 5,5x23,0; 1x 6,0x23,0; 1x 7,0x23,0; 1x 8,0x23,0; 1x 10,0x23,0; 1x 11,0x23,0; 1x 12,0x23,0; 1x 13,0x23,0	
	8794 LA	1x 1/4"x150,0	
	8794 A	1x 1/4"x56,0	
	8784 A1	1x 1/4"x1/4"x37,0	
	851/1 Z	1x PH 1x25; 1x PH 2x25; 1x PH 3x25	
	855/1 Z	1x PZ 1x25; 1x PZ 2x25	
	867/1 TORX®	1x TX 10x25; 1x TX 15x25; 1x TX 20x25; 1x TX 25x25; 1x TX 27x25; 1x TX 30x25	
	840/1 Z	1x 3,0x25; 1x 4,0x25; 1x 5,0x25; 1x 6,0x25	



8100 SB 7 Zyklop Metal Ratchet Set with push-through square, 3/8" drive, metric



8100 SC 7 Zyklop Metal Ratchet Set with push-through square, 1/2" drive, metric



29-piece set; in a surface-preserving, compact and extremely robust textile box; low volume and weight for simplified mobility

1 Zyklop Metal Ratchet with 3/8" drive, 9 Zyklop sockets, 1 Zyklop extension (long) with free-turning sleeve, 1 wobble extension, 1 adaptor with quick-release chuck, 16 bits



28-piece set; in a surface-preserving, compact and extremely robust textile box; low volume and weight for simplified mobility

1 Zyklop Metal Ratchet with push-through square and 1/2" drive, 10 Zyklop sockets, 1 Zyklop extension (long) with free-turning sleeve, 1 wobble extension, 1 adaptor with quick-release chuck, 14 bits

05004047001		
○	8003 B	1x 3/8"x222,0
●	8790 HMB	1x 8,0x29,0; 1x 10,0x29,0; 1x 12,0x29,0; 1x 13,0x29,0; 1x 15,0x29,0; 1x 16,0x30,0; 1x 17,0x30,0; 1x 18,0x30,0; 1x 19,0x30,0
○	8794 LB	1x 3/8"x200,0
○	8794 B	1x 3/8"x76,0
○	8784 B1	1x 1/4"x3/8"x44,0
+	851/1 Z	1x PH 1x25; 1x PH 2x25; 1x PH 3x25
+	855/1 Z	1x PZ 1x25; 1x PZ 2x25
+	867/1 TORX®	1x TX 15x25; 1x TX 20x25; 1x TX 25x25; 1x TX 27x25; 1x TX 30x25; 1x TX 40x25
○	840/1 Z	1x 3,0x25; 1x 4,0x25; 1x 5,0x25; 1x 6,0x25; 1x 8,0x25

05004077001		
○	8003 C	1x 1/2"x281,0
●	8790 HMC	1x 10,0x37,0; 1x 11,0x37,0; 1x 12,0x37,0; 1x 13,0x37,0; 1x 14,0x37,0; 1x 15,0x37,0; 1x 16,0x37,0; 1x 17,0x37,0; 1x 18,0x37,0; 1x 19,0x37,0
○	8794 LC	1x 1/2"x250,0
○	8794 C	1x 1/2"x52,0
○	8784 C2	1x 5/16"x1/2"x50,0
+	851/2 Z	1x PH 2x32; 1x PH 3x32
+	867/2 Z TORX®	1x TX 20x35; 1x TX 25x35; 1x TX 27x35; 1x TX 30x35; 1x TX 40x35; 1x TX 45x35; 1x TX 50x35; 1x TX 55x35
○	840/2 Z	1x 5x30; 1x 6x30; 1x 8x30; 1x 10x30



Reversible



Switch lever for convenient change of direction.



8004 A Zyklop Metal Ratchet with switch lever and 1/4" drive



Application: 1/4" square sockets as well as for 1/4" adaptors with square drive, with ball locking device

Design: Forged, full metal ratchet (chrome-molybdenum) that is extremely robust with a long service life; slim design to enable work in very confined spaces; fine-tooth mechanism with 72 teeth for a return angle of only 5°; switch lever for convenient change of direction; secure socket locking function

	mm	mm	mm	mm
05004004001	1/4"	141	19	22

8004 B Zyklop Metal Ratchet with switch lever and 3/8" drive

	mm	mm	mm	mm
05004034001	3/8"	222,0	26	29

8004 C Zyklop Metal Ratchet with switch lever and 1/2" drive

	mm	mm	mm	mm
05004064001	1/2"	281	34	37

8100 SA 8 Zyklop Metal Ratchet Set with switch lever, 1/4" drive, metric



28-piece set; in a surface-preserving, compact and extremely robust textile box; low volume and weight for simplified mobility

1 Zyklop Metal Ratchet with switch lever and 1/4" drive, 9 Zyklop sockets, 1 Zyklop extension (long) with free-turning sleeve, 1 wobble extension, 1 adaptor with quick-release chuck, 15 bits

05004018001		
	8004 A	1x 1/4"x141
	8790 HMA	1x 5,0x23,0; 1x 5,5x23,0; 1x 6,0x23,0; 1x 7,0x23,0; 1x 8,0x23,0; 1x 10,0x23,0; 1x 11,0x23,0; 1x 12,0x23,0; 1x 13,0x23,0
	8794 LA	1x 1/4"x150,0
	8794 A	1x 1/4"x56,0
	8784 A1	1x 1/4"x1/4"x37,0
	851/1 Z	1x PH 1x25; 1x PH 2x25; 1x PH 3x25
	855/1 Z	1x PZ 1x25; 1x PZ 2x25
	867/1 TORX®	1x TX 10x25; 1x TX 15x25; 1x TX 20x25; 1x TX 25x25; 1x TX 27x25; 1x TX 30x25
	840/1 Z	1x 3,0x25; 1x 4,0x25; 1x 5,0x25; 1x 6,0x25
	Hook and Loop Fastener Strip 120	1x 50,0x120,0



8100 SB 8 Zyklop Metal Ratchet Set with switch lever, 3/8" drive, metric



29-piece set; in a surface-preserving, compact and extremely robust textile box; low volume and weight for simplified mobility

1 Zyklop Metal Ratchet with 3/8" drive, 9 Zyklop sockets, 1 Zyklop extension (long) with free-turning sleeve, 1 wobble extension, 1 adaptor with quick-release chuck, 16 bits

05004048001		
○	8004 B	1x 3/8"x222,0
●	8790 HMB	1x 8,0x29,0; 1x 10,0x29,0; 1x 12,0x29,0; 1x 13,0x29,0; 1x 15,0x29,0; 1x 16,0x30,0; 1x 17,0x30,0; 1x 18,0x30,0; 1x 19,0x30,0
○	8794 LB	1x 3/8"x200,0
○	8794 B	1x 3/8"x76,0
○	8784 B1	1x 1/4"x3/8"x44,0
+	851/1 Z	1x PH 1x25; 1x PH 2x25; 1x PH 3x25
+	855/1 Z	1x PZ 1x25; 1x PZ 2x25
+	867/1 TORX®	1x TX 15x25; 1x TX 20x25; 1x TX 25x25; 1x TX 27x25; 1x TX 30x25; 1x TX 40x25
○	840/1 Z	1x 3,0x25; 1x 4,0x25; 1x 5,0x25; 1x 6,0x25; 1x 8,0x25

8100 SC 8 Zyklop Metal Ratchet Set with switch lever, 1/2" drive, metric



28-piece set; in a surface-preserving, compact and extremely robust textile box; low volume and weight for simplified mobility

1 Zyklop Metal Ratchet with switch lever and 1/2" drive, 10 Zyklop sockets, 1 Zyklop extension (long) with free-turning sleeve, 1 wobble extension, 1 adaptor with quick-release chuck, 14 bits

05004078001		
○	8004 C	1x 1/2"x281,0
●	8790 HMC	1x 10,0x37,0; 1x 11,0x37,0; 1x 12,0x37,0; 1x 13,0x37,0; 1x 14,0x37,0; 1x 15,0x37,0; 1x 16,0x37,0; 1x 17,0x37,0; 1x 18,0x37,0; 1x 19,0x37,0
○	8794 LC	1x 1/2"x250,0
○	8794 C	1x 1/2"x52,0
○	8784 C2	1x 5/16"x1/2"x50,0
+	851/2 Z	1x PH 2x32; 1x PH 3x32
+	867/2 Z TORX®	1x TX 20x35; 1x TX 25x35; 1x TX 27x35; 1x TX 30x35; 1x TX 40x35; 1x TX 45x35; 1x TX 50x35; 1x TX 55x35
○	840/2 Z	1x 5x30; 1x 6x30; 1x 8x30; 1x 10x30

Tool-Check PLUS



28 bits, 1 bitholding screwdriver 813 suitable for the attachment of bits with 1/4" hexagon drive as per DIN ISO 1173-C 6.3 and Wera connection series 1, 1 Rapidaptor bit holder, 1 adaptor 870/1 (1/4" hexagon to 1/4" square), 7 sockets (1/4"); 1 Wera Bit Ratchet Zyklop Mini 1, drop-forged full steel design suitable for the attachment of bits with 1/4" hexagon drive as per DIN ISO 1173-C 6.3 and E 6.3 and Wera connection series 1 and 4; the use of 1/4" sockets is also possible with the application of the Wera adaptor 870/1

05056490001		
●	8001 A	1x 1/4"x87,0
●	813	1x 1/4"x78
●○	889/4/1 K	1x 1/4"x50
○○	870/1	1x 1/4"x25 ¹⁾
●	8790 HMA	1x 5,5x23,0; 1x 6,0x23,0; 1x 7,0x23,0; 1x 8,0x23,0; 1x 10,0x23,0; 1x 12,0x23,0; 1x 13,0x23,0
+	851/1 TZ	2x PH 1x25; 3x PH 2x25; 1x PH 3x25
+	855/1 TH	1x PZ 1x25; 3x PZ 2x25; 1x PZ 3x25
⊗	867/1 TZ TORX®	1x TX 10x25; 1x TX 15x25; 1x TX 20x25; 1x TX 25x25; 1x TX 30x25; 1x TX 40x25
⊗	867/1 Z TORX® BO	1x TX 10x25; 1x TX 15x25; 1x TX 20x25; 1x TX 25x25; 1x TX 30x25
○	840/1 Z	1x 3,0x25; 1x 4,0x25; 1x 5,0x25; 1x 6,0x25; 1x 8,0x25
⊖	800/1 TZ	1x 1,0x5,5x25

¹⁾ With friction ball; for manual nut spinner sockets

Tool-Check PLUS



Tool combination of 1/4" Zyklop Mini ratchet, sockets, one bitholding screwdriver and bits in a space-saving Tool-Check PLUS case made of robust plastic.

Rapid screwdriving



High working speeds can be attained with the Zyklop Mini bit ratchet. The thumb wheel is important, enabling more rapid screwdriving, and the lever of the Zyklop Mini only needs to be used for the final tightening of the screw.

Is such a small tool sufficiently resilient?



The 8001 A Zyklop Mini 1 can withstand at least 65 Nm. That is far more power than can normally be transferred to such a small tool.

Bit-Check 10 Zyklop Mini BiTorsion 1



9 bits, BiTorsion for long service life, extra-tough, for universal use. Take it easy tool finder: Output colour coding (red = Phillips; black = Pozidriv; green = TORX®; blue = hexagon) and large stamp to enable the desired bit to be easily located. 1 Wera Bit Ratchet Zyklop Mini 1, drop-forged full steel design, suitable for 1/4" hex bits as per DIN ISO 1173-C 6.3 and E 6.3 and Wera series 1 and 4. Can also be used with 1/4" sockets by using the Wera socket adaptor 870/1.

05057418001		
●	8001 A	1x 1/4"x87,0
+	851/1 BTZ	1x PH 1x25; 1x PH 2x25
+	855/1 BTZ	1x PZ 1x25; 1x PZ 2x25
⊗	867/1 TORX® BTZ	1x TX 15x25; 1x TX 20x25; 1x TX 25x25
○	840/1 BTZ	1x 4,0x25; 1x 5,0x25

8001 A Zyklop Mini 1 Bit Ratchet 1/4" SB with 1/4" drive



Application: Suitable for 1/4" hex bits as per DIN ISO 1173-C 6.3 and E 6.3 and Wera series 1 and 4, Wera adaptor 870/1 for 1/4" sockets

Design: Drop-forged full steel design, fine-tooth ratchet mechanism, small return angle of 6°, forward and reverse drive switch

Handle: Kraftform handle with proven Kraftform geometry provides perfectly designed finger contact zones, ergonomic ratchet head and handle

05073230001		
●	8001 A	1x 1/4"x87,0
○●	870/1	1x 1/4"x25 ¹⁾

¹⁾ With friction ball; for manual nut spinner sockets

8005 Zyklop Mini 2 Ratchet



Application: Suitable for Wera sockets 8790 FA

Design: Drop-forged full steel design, fine-tooth ratchet mechanism, small return angle of 6°, forward and reverse drive switch

Handle: Kraftform handle with proven Kraftform geometry provides perfectly designed finger contact zones, ergonomic ratchet head and handle

	⌀
	mm
05003660001	107

8008 A Zyklop Mini 3 Ratchet with 1/4" drive

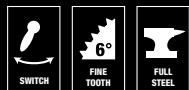

Application: 1/4" square sockets and 1/4" adaptors with square drive, equipped with ball lock

Design: Drop-forged full steel design, fine-tooth ratchet mechanism, small return angle of 6°, forward and reverse drive switch

Handle: Kraftform handle with proven Kraftform geometry provides perfectly designed finger contact zones, ergonomic ratchet head and handle

05003793001		
■	⌀	
	mm	
1/4"	87,0	

781/5 Set 1

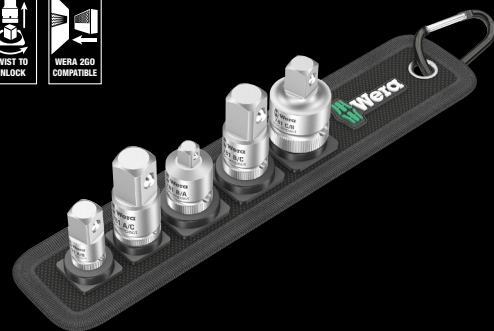

Connection parts, 5-piece set

For manual and machine-operated tools (non-impact), with ball stop groove, knurling at the rear end for manageability during manual use; chrome-vanadium, brushed chrome-plated finish

781 A: 1/4" socket square head drive, for 3/8" and 1/2" square head socket wrench inserts with ball lock; 781 B: 3/8" socket square head drive, for 1/4" and 1/2" square head socket wrench inserts with ball lock; 781 C: 1/2" socket square head drive, for 3/8" square head socket wrench inserts with ball lock.

05042680001		
○●	781 A	1x 781 A/B, 3/8"x25,2x1/4"; 1x 781 A/C, 1/2"x36,0x1/4"
○●	781 B	1x 781 B/A, 1/4"x27,0x3/8"; 1x 781 B/C, 1/2"x36,0x3/8"
○●	781 C	1x 781 C/B, 3/8"x35,5x1/2"
	Belt 781 0/5	1x 45,0x210,0

Belt A 1 Zyklop socket set with holding function, 1/4" drive



10-piece set; robust textile socket belt, including snap hook to enable secure fastening to a belt loop or pocket. Non-woven reverse side and hook and loop strips for simple attachment e.g. to a wall, shelf, tool trolley and to the Wera 2go tool transport system. Fast and easy Twist to Unlock mechanism for secure storage and simple removal of the sockets.

9 Zyklop sockets with 1/4" drive with fastener holding function. "Take it easy" tool finder: Colour coding to enable the desired socket to be easily selected. 1 tool for the simple removal of nuts from sockets with holding function.

05003880001	
●	8790 HMA HF 1x 4,0x23,0; 1x 4,5x23,0; 1x 5,0x23,0; 1x 5,5x23,0; 1x 6,0x23,0; 1x 7,0x23,0; 1x 8,0x23,0; 1x 10,0x23,0; 1x 13,0x23,0
	Nut Extractor 1x 14,0x43,0
	Belt A 0/9 1x 39,0x238,0
	Hook and Loop Fastener Strip 30 1x 30,0x200,0

Belt B 3 TORX® HF Zyklop bit socket set with holding function, 3/8" drive



9-piece set; robust textile socket belt, including snap hook to enable secure fastening to a belt loop or pocket. Non-woven reverse side and hook and loop strips for simple attachment e.g. to a wall, shelf, tool trolley and to the Wera 2go tool transport system. Fast and easy Twist to Unlock mechanism for secure storage and simple removal of the tool sockets.

9 Zyklop bit sockets for TORX® screws, with 3/8" drive, with holding function. "Take it easy" tool finder: Colour coding to enable the desired bit socket to be easily selected.

05003972001	
♻️	8767 B HF 1x TX 10x35,0; 1x TX 15x35,0; 1x TX 20x35,0; 1x TX 25x35,0; 1x TX 27x35,0; 1x TX 30x35,0; 1x TX 40x35,0; 1x TX 45x38,5; 1x TX 50x38,5
	Belt B 0/9 1x 45,0x310,0
	Hook and Loop Fastener Strip 30 1x 30,0x200,0

Belt A Deep 1 socket set, 1/4" drive

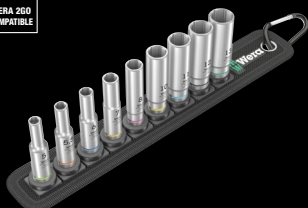

9-piece set; robust textile socket belt, including snap hook to enable secure fastening to a belt loop or pocket. Non-woven reverse side and hook and loop strips for simple attachment e.g. to a wall, shelf, tool trolley and to the Wera 2go tool transport system. Smooth turning Fast and easy Twist to Unlock mechanism for secure storage and simple removal of the sockets.

9 sockets with 1/4" drive. Long design for low-profile screwdriving and protruding threaded rods, with hexagonal profile. "Take it easy" tool finder: Colour coding to enable the desired socket to be easily selected.

05004525001	
●	8790 HMA Deep 1x 5,0x50,0; 1x 5,5x50,0; 1x 6,0x50,0; 1x 7,0x50,0; 1x 8,0x50,0; 1x 10,0x50,0; 1x 11,0x50,0; 1x 12,0x50,0; 1x 13,0x50,0
	Belt A 0/9 1x 39,0x238,0
	Hook and Loop Fastener Strip 30 1x 30,0x200,0

Belt C Deep 1 socket set, 1/2" drive



6-piece set; robust textile socket belt, including snap hook to enable secure fastening to a belt loop or pocket. Non-woven reverse side and hook and loop strips for simple attachment e.g. to a wall, shelf, tool trolley and to the Wera 2go tool transport system. Smooth turning Fast and easy Twist to Unlock mechanism for secure storage and simple removal of the sockets.

6 sockets with 1/2" drive. Long design for low-profile screwdriving and protruding threaded rods, with hexagonal profile. "Take it easy" tool finder: Colour coding to enable the desired socket to be easily selected.

05004565001	
●	8790 HMC Deep 1x 10,0x83,0; 1x 13,0x83,0; 1x 15,0x83,0; 1x 16,0x83,0; 1x 17,0x83,0; 1x 19,0x83,0
	Belt C 0/6 1x 45,0x275,0
	Hook and Loop Fastener Strip 30 1x 30,0x200,0

8790 HMC HF 1 Zyklop socket set with 1/2" drive, with holding function



10-piece set; in a surface-preserving, compact and extremely robust textile box; low volume and weight for simplified mobility

10 Zyklop sockets with 1/2" drive with holding function. Take it easy tool finder: Colour coding and large stamp to enable the desired socket to be easily located.

05004203001	
●	8790 HMC HF 1x 10,0x37,0; 1x 11,0x37,0; 1x 12,0x37,0; 1x 13,0x37,0; 1x 14,0x37,0; 1x 15,0x37,0; 1x 16,0x37,0; 1x 17,0x37,0; 1x 18,0x37,0; 1x 19,0x37,0
	Hook and Loop Fastener Strip 120 1x 50,0x120,0

8740 C HF 2 Zyklop bit socket set with 1/2" drive, with holding function

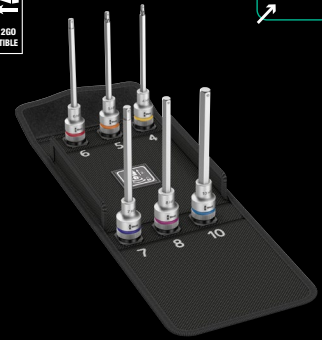

9-piece set; in a surface-preserving, compact and extremely robust textile box; low volume and weight for simplified mobility

9 Zyklop bit sockets, 140 mm long, for hexagon socket screws, with 1/2" drive, with holding function

05004210001	
○	8740 C HF 1x 4,0x140,0; 1x 5,0x140,0; 1x 6,0x140,0; 1x 7,0x140,0; 1x 8,0x140,0; 1x 10,0x140,0
	Hook and Loop Fastener Strip 120 1x 50,0x120,0

Belt C Impaktor 1 socket set, 1/2" drive



9-piece set; robust textile socket belt, including snap hook to enable secure fastening to a belt loop or pocket. Non-woven reverse side and hook and loop strips for simple attachment e.g. to a wall, shelf, tool trolley and to the Wera 2go tool transport system. Fast and easy Twist to Unlock mechanism for secure storage and simple removal of the sockets.

9 Impaktor sockets with 1/2" drive, with hexagonal profile and grooved socket. For use with electric or pneumatic powered impact wrenches with 12.5mm = 1/2" drive. "Take it easy" tool finder: Colour coding to enable the desired socket to be easily selected.

05004580001	
●	8790 C Impaktor 1x 13,0x38,0; 1x 14,0x38,0; 1x 15,0x38,0; 1x 16,0x38,0; 1x 17,0x38,0; 1x 18,0x38,0; 1x 19,0x38,0; 1x 20,0x38,0; 1x 21,0x38,0
	Belt C Impaktor 0/9 1x 71,0x210,0
	Hook and Loop Fastener Strip 30 1x 30,0x200,0

8790 C Impaktor Deep Set 1

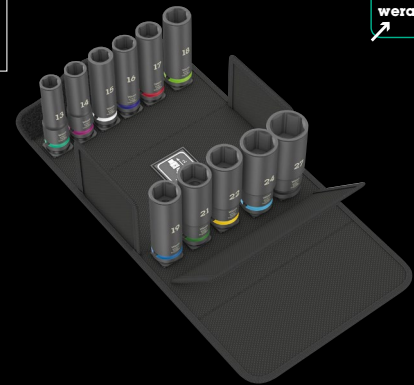

11-piece set; in a surface-friendly, compact and extremely robust textile box. Small size and low weight for better mobility.

11 Impaktor sockets with 1/2" drive; for use with electric or pneumatic wrenches with 12.5 mm = 1/2" drive; with hole for locking pin; long design for low-lying couplings and protruding thread rods; with hexagon profile; chromium molybdenum, matt-black. "Take it easy" tool finder: With colour coding by size as well as size stamping - for quick and easy identification of the required bit socket.

05004841001	
●	8790 C Impaktor Deep 1x 13,0x83,0; 1x 14,0x83,0; 1x 15,0x83,0; 1x 16,0x83,0; 1x 17,0x83,0; 1x 18,0x83,0; 1x 19,0x83,0; 1x 21,0x83,0; 1x 22,0x83,0; 1x 24,0x83,0; 1x 27,0x83,0

Kraftform Kompakt W 1 Maintenance



35-piece set; in surface-protecting, compact textile box, highly robust; low volume and weight for simplified mobility.

Compact tool set with the most important screwdriving tools for maintenance jobs both indoors as well as outdoors. One Kraftform 817 VDE bitholding screwdriver solely for Wera VDE blades; 12 VDE blades (each 157 mm length) with Take it easy toolfinder with colour coding by profile and laser-engraved size indication; 1 Joker double open-ended wrench with holding function, limit stop, small return angle and extremely high-grip toothing; incl. the incredibly fast 1/4" Zyklop Speed ratchet with accessories; 8 manual and power tool sockets in the dimensions 5.5-13, 1 universal bit holder; 7 25mm bits; 1 screw gripper to firmly hold screws; 1 single-pole phase tester 247; textile box that is very robust and durable; can be positioned upright in the workshop shelf for tidy storage; additional surface protection thanks to the textile outer material; low weight and volume for simplified mobility.

Kraftform Kompakt W 1 Maintenance



The perfect set for diverse maintenance jobs both indoors as well as outdoors - applications: electronics, mechatronics, building technology, photovoltaic etc. etc. etc.

Handle/interchangeable blade system

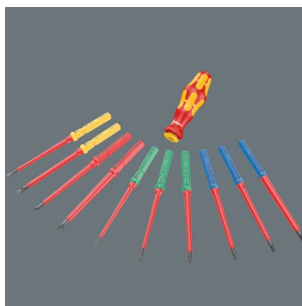

The handle/interchangeable blade system allows rapid exchange of the blades required for a wide range of applications.

Zyklop "6 in 1"



1. Fine-tooth ratchet 2. Flex-head ratchet 3. Angle ratchet 4. Quick-release ratchet 5. Power ratchet 6. Screwdriver

05135926001		
☉	817 VDE	1x 9x98
☉	Kraftform Kompakt VDE 60 i Take it easy	1x 0,4x2,5x157
☉	Kraftform Kompakt VDE 60 iS Take it easy	1x 0,6x3,5x157; 1x 0,8x4,0x157; 1x 1,0x5,5x157
⊕	Kraftform Kompakt VDE 62 iS Take it easy	1x PH 1x157; 1x PH 2x157
⊕	Kraftform Kompakt VDE 65 iS Take it easy	1x PZ 1x157; 1x PZ 2x157
⊗	Kraftform Kompakt VDE 67 i Take it easy	1x TX 10x157
⊗	Kraftform Kompakt VDE 67 iS Take it easy	1x TX 15x157; 1x TX 20x157; 1x TX 25x157
	1440	1x 4,5-6,0x41,0
☉	247	1x 0,5x3,0x70
	6002 Joker Double	1x 10x13x167
⊙	8000 A	1x 1/4"x152,0
⊙	8784 A1	1x 1/4"x1/4"x37,0
⊙	8794 SA	1x 1/4"x75,0
⊙	8790 HMA	1x 5,5x23,0; 1x 6,0x23,0; 1x 7,0x23,0; 1x 8,0x23,0; 1x 10,0x23,0; 1x 11,0x23,0; 1x 12,0x23,0; 1x 13,0x23,0
⊙	893/4/1 K	1x 1/4"x50
⊕	855/1 Z	1x PZ 1x25; 1x PZ 2x25
⊙	840/1 Z	1x 3,0x25; 1x 4,0x25; 1x 5,0x25; 1x 6,0x25
⊗	867/1 TORX®	1x TX 25x25
	Hook and Loop Fastener Strip 240	1x 50,0x240,0

Kraftform Kompakt F 1 screwdriving tool set for window installation



36-piece set; in a surface-preserving, compact and extremely robust textile box. Low volume and weight for simplified mobility.

Compact tool set for professional window installation. 1x 393 S extra slim bitholding screwdriver with flexible shaft, with a compact stainless steel holder and strong permanent magnet, secure bit holding feature due to locking mechanism for the application in hard-to-reach installation spaces, 1x 813 bit holder, 14 bits, 1x 1/4" Zyklop Mini 8001 A bit-ratchet, 1x 870/1 adapter (1/4"-hexagon to 1/4"-square head) 1 Zyklop 8794 SA extention, 1/4", short, for socket wrench inserts, 4 Zyklop socket wrench inserts, 2 Hex-Plus L-keys for hexagonal socket screws, 3 Hex-Plus L-keys with holding function for hexagonal socket screws, 6 L-keys with holding function for TORX® screws, 1x 6004 S self-setting spanner for hexagon screw heads and bolts with wrench size 10-13 (metric) or 7/16"-1/2" (imperial).

05134013001		
●	393 S	1x 1/4"x173,5
●	813	1x 1/4"x78
●	8001 A	1x 1/4"x87,0
○	870/1	1x 1/4"x25 ¹⁾
□	8794 SA	1x 1/4"x75,0
●	8790 HMA	1x 7,0x23,0; 1x 8,0x23,0; 1x 10,0x23,0; 1x 13,0x23,0
+	851/4 TZ	1x PH 1x50; 1x PH 2x50; 1x PH 3x50
⊕	867/4 Z	1x TX 8x50; 1x TX 10x50; 1x TX 15x50; TORX® 1x TX 20x50; 1x TX 25x50; 1x TX 30x50
○	840/4 Z	1x 2,0x50; 1x 2,5x50; 1x 3,0x50; 1x 4,0x50; 1x 5,0x50; 1x 6,0x89 ²⁾
○	950 SPKL Multicolour	1x 2,0x101; 1x 2,5x112
○	950 SPKL HF Multicolour	1x 3,0x123; 1x 4,0x137; 1x 5,0x154
⊕	967 SXL HF TORX® Multi-colour	1x TX 8x90; 1x TX 10x112; 1x TX 15x123; 1x TX 20x137; 1x TX 25x154; 1x TX 30x195
○	6004 Joker S	1x 10-13x7/16"-1/2"x154

¹⁾ With friction ball; for manual nut spinner sockets

²⁾ Hexagonal blade



Tool set for the professional window builder

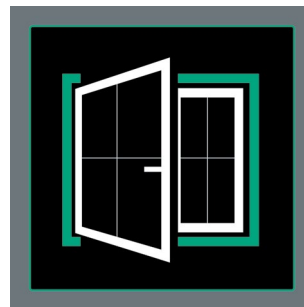

Compact Wera screwdriving tool set with the 35 most important tools for window construction. Socket and bit assortment in premium Wera quality, attuned to universal window construction applications. With 2 bit hand holders and 1 bit ratchet (which can also be used for sockets, if used with an adaptor).



Flexible shaft



Around the corner screwdriving with the 393 S bitholding screwdriver. The flexible shaft allows to reach fixing screws in unfavourable positions. The ideal tool for screwdriving situations that are difficult to reach.



Kraftform Kompakt SH 2 PlumbKit

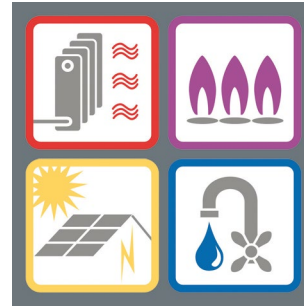

Compact tool set with the 15 most important screwdriving tools for plumbing and heating applications.



Hollow shaft nutsetter

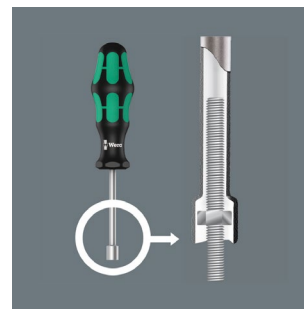

A screwdriver with a hollow shaft is needed whenever there are screwdriving jobs involving threaded rods i.e. the threaded rod through the nut can slip into the hollow shaft of the screwdriver.

Kraftform Kompakt SH 2 PlumbKit



15-piece set; in a surface-preserving, compact and extremely robust textile box; low volume and weight for simplified mobility.

1 Kraftform chiseldriver 932 A (slotted) with pound-thru hexagonal blade and integrated impact cap for screwdriving and light chiselling; 2 socket wrench screwdrivers 395 HO with hollow shaft for tightening or loosening nuts on protruding threaded rods as well as fixed screws; 1 Kraftform Kompakt VDE handle, 4 Kraftform Kompakt VDE interchangeable blades with reduced blade diameter and integrated protective insulation, so low-lying screws can be accessed, individually tested as per IEC 60900; 1 single-pole phase tester 247, 2 Joker Switch ratcheting combination wrenches with holding function for nuts and bolts, protecting against slippage, double hexagon geometry and extremely hard tips on the metal plate to protect against slippage at high torques, with a small return angle of 30°, switch lever for a comfortable direction change, ring end angled at 15° from the handle; 4 L-keys with Hex-Plus profile (prevents the rounding of hexagon socket screws), with holding function for hexagon socket screws, hexagonal ball-end on the long arm, BlackLaser surface, plastic sleeve, all L-keys are easily identified by their colour coding and size marking.



05136026001		
⊙	395 HO	1x 10,0x90; 1x 13,0x90
⊖	932 A	1x 1,2x7,0x125
	6001 Joker Switch	1x 10x159; 1x 13x179
○	950 SPKL HF Multi-colour	1x 3,0x123; 1x 4,0x137; 1x 5,0x154; 1x 6,0x172
⊙	817 VDE	1x 9x102
+	Kraftform Kompakt VDE 62 iS Take it easy	1x PH 1x157; 1x PH 2x157
⊖	Kraftform Kompakt VDE 60 iS Take it easy	1x 0.6x3.5x157; 1x 1.0x5.5x157
⊖	247	1x 0,5x3,0x70
⊖	K240	1x 50,0x240,0

⁷ Product not available in the USA and Canada.

Kraftform Kompakt H 1 Woodcraft



41-piece set; in surface-protecting, compact textile box, highly robust; low volume and weight for simplified mobility.

Compact tool set with the 41 most important screwdriving tools for jobs involving wood: including the robust Bit Ratchet Zyklop Mini with extension and socket adaptor; 8 manual and power tool sockets in the dimensions 5.5-13; 1 hand holder 816 RA with ratchet function, fine toothing for small return angle, switch-over ring (right, fixed, left), maximum torque 50 Nm and bit take-up with Rapidaptor technology; 1 universal bit holder; 6 bits of 25mm in length; 16 bits of 89 mm in length; 5 twist drill bits for wood with a diameter of 3-8mm; 1 screw gripper to firmly hold screws; 1 single-pole phase tester 247; textile box that is very robust and durable; can be positioned upright in the workshop shelf for tidy storage; additional surface protection thanks to the textile outer material; low weight and volume for simplified mobility.

Kraftform Kompakt M 1 Metal



39-piece set; in surface-protecting, compact textile box, highly robust; low volume and weight for simplified mobility.

Compact tool set with the 39 most important screwdriving tools for jobs involving metal, including the incredibly fast 1/4" Zyklop Speed ratchet with accessories; 7 manual and power tool sockets in the dimensions 5.5-13; 1 bit hand holder; 13 bits of 89 mm in length; 6 combination screw tap bits; 6 twist drill bits for metal with a diameter of 3-10mm; 1 screw gripper to firmly hold screws; 1 single-pole phase tester 247; textile box that is very robust and durable; can be positioned upright in the workshop shelf for tidy storage; additional surface protection thanks to the textile outer material; low weight and volume for simplified mobility.

05135939001		
⊙	816 RA	1x 1/4"x142,0
⊙	8001 A	1x 1/4"x87,0
⊙⊙	870/1	1x 1/4"x25 ¹⁾
⊙⊙	8794 SA	1x 1/4"x75,0
⊙	8790 HMA	1x 5,5x23,0; 1x 6,0x23,0; 1x 7,0x23,0; 1x 8,0x23,0; 1x 10,0x23,0; 1x 12,0x23,0; 1x 13,0x23,0
⊙⊙	893/4/1 K	1x 1/4"x50
⊕	851/4 Z	1x PH 1x89; 1x PH 2x89; 1x PH 3x89 ²⁾
⊕	855/4 Z	1x PZ 1x89; 1x PZ 2x89; 1x PZ 3x89 ²⁾
⊕	855/1 Z	1x PZ 1x25; 1x PZ 2x25; 1x PZ 3x25
⊕	867/4 Z TORX® BO	1x TX 10x89; 1x TX 15x89; 1x TX 20x89; 1x TX 25x89; 1x TX 30x89
⊕	867/1 TORX®	1x TX 20x25; 1x TX 25x25
⊙	840/4 Z	1x 3,0x89; 1x 4,0x89; 1x 5,0x89; 1x 6,0x89 ²⁾
⊖	800/4 Z	1x 1,0x5,5x89
⊖	800/1 Z	1x 1,0x5,5x25
⊗	849 HSS	1x 3,0x70,0; 1x 4,0x74,0; 1x 5,0x85,0; 1x 6,0x95,0; 1x 8,0x110,0
⊖	247	1x 0,5x3,0x70
⊖	1441	1x 4,5-6,0x41,0

¹⁾ With friction ball; for manual nut spinner sockets

²⁾ Hexagonal blade

³⁾ Product not available in the USA and Canada.

05135928001		
⊙	8000 A	1x 1/4"x152,0
⊙⊙	8794 LA	1x 1/4"x150,0
⊙⊙	8794 A	1x 1/4"x56,0
⊙⊙	8784 A1	1x 1/4"x1/4"x37,0
⊙	816 R	1x 1/4"x119
⊙	8790 HMA	1x 5,5x23,0; 1x 6,0x23,0; 1x 7,0x23,0; 1x 8,0x23,0; 1x 10,0x23,0; 1x 12,0x23,0; 1x 13,0x23,0
⊕	851/4 Z	1x PH 1x89; 1x PH 2x89; 1x PH 3x89 ¹⁾
⊙	840/4 Z	1x 3,0x89; 1x 4,0x89; 1x 5,0x89; 1x 6,0x89 ¹⁾
⊕	867/4 Z TORX®	1x TX 10x89; 1x TX 15x89; 1x TX 20x89; 1x TX 25x89; 1x TX 30x89
⊖	800/4 Z	1x 1,0x5,5x89
⊗	847 HSS	1x 2,5x36,0xM 3; 1x 3,3x39,0xM 4; 1x 4,2x41,0xM5; 1x 5,0x44,0xM6; 1x 6,8x51,0xM8; 1x 8,5x59,0xM 10
⊗	848 HSS	1x 3,0x38,0; 1x 4,0x44,0; 1x 5,0x50,0; 1x 6,0x50,0; 1x 8,0x51,0; 1x 10,0x54,0
	1441	1x 4,5-6,0x41,0
⊖	247	1x 0,5x3,0x70
	Hook and Loop Fastener Strip 240	1x 50,0x240,0

¹⁾ Hexagonal blade

²⁾ Product not available in the USA and Canada.



Bicycle Set 7



27-piece set; in surface-friendly, compact and extremely robust textile box. Small size and low weight for better mobility.

1 Zyklop Speed ratchet with $\frac{3}{8}$ " drive, 10 Zyklop sockets, 2 Zyklop bit sockets with 30 mm and extra slim profile area for better accessibility in tight workspaces, with Take it easy tool finder: Colour coding by size. 1 Zyklop extension (short) with fast-rotating sleeve, 1 Wobble extension, 1 bit adapter, 1 connection part $\frac{3}{8}$ " external square head to $\frac{1}{2}$ " external square head, 10 bits, tough, for universal use. Incredibly compact set arrangement for many tools in a tight space thanks to the highly robust and durable textile box. Can be placed in an upright position for clearly arranged storage in the workshop shelf. Additional surface protection thanks to textile outer material. Low weight and small size for better mobility.

05004175001		
○	8000 B	1x $\frac{3}{8}$ "x199,0
●	8790 HMB	1x 6,0x29,0; 1x 7,0x29,0; 1x 8,0x29,0; 1x 9,0x29,0; 1x 10,0x29,0; 1x 11,0x29,0; 1x 12,0x29,0; 1x 13,0x29,0; 1x 14,0x29,0
●	8790 HMB Deep	1x 15,0x64,0
○	8740 B	1x 8,0x100,0; 1x 10,0x100,0
○	8794 B	1x $\frac{3}{8}$ "x76,0
○	8784 B1	1x $\frac{1}{4}$ "x $\frac{3}{8}$ "x44,0
○	8794 SB	1x $\frac{3}{8}$ "x125,0
○	781 B	1x 781 B/C, $\frac{1}{2}$ "x36,0x $\frac{3}{8}$ "
○	840/4 Z	1x 3,0x50; 1x 4,0x50; 1x 5,0x50; 1x 6,0x50 ¹⁾
⊕	867/4 Z TORX®	1x TX 10x50; 1x TX 15x50; 1x TX 20x50; 1x TX 25x50; 1x TX 27x50; 1x TX 30x50

¹⁾ Hexagonal blade

Bicycle Set 3 A



38-piece set

One chain riveter, one chain fastener, 22 bits, one 813 bitholding screwdriver suitable for bits with $\frac{1}{4}$ " external hexagon drive as per DIN ISO 1173-C 6.3 and E 6.3 and Wera connection series 1, one universal bit holder, stainless steel, one Rapidaptor bit holder, one 870/1 adapter ($\frac{1}{4}$ " hexagon to $\frac{1}{4}$ " square head), 7 sockets ($\frac{1}{4}$ "). One Wera Zyklop Mini 1 bit ratchet, drop-forged solid steel design; suitable for mounting bits with $\frac{1}{4}$ " external hexagon drive as per DIN ISO 1173-C 6.3 and Wera connection series 1 and 4; $\frac{1}{4}$ " sockets can also be used by adapting the Wera 870/1 adapter; one 9502 tyre jack with bit mounting, one 9503 tyre jack with valve ejector. One robust textile pouch 9481 for clean storage of the Tool-Check. One soft pouch 9480 to take individual tools with you on the bike.

05004183001		
●	8001 A	1x $\frac{1}{4}$ "x87,0
●	813	1x $\frac{1}{4}$ "x78
○	3899/4/1	1x $\frac{1}{4}$ "x100
○	889/4/1 K	1x $\frac{1}{4}$ "x50
○	870/1	1x $\frac{1}{4}$ "x25 ¹⁾
●	8790 HMA	1x 5,5x23,0; 1x 6,0x23,0; 1x 8,0x23,0; 1x 9,0x23,0; 1x 10,0x23,0; 1x 13,0x23,0; 1x 15,0x23,0
⊕	851/1 TZ	1x PH 1x25; 1x PH 2x25
⊕	867/1 TZ TORX®	1x TX 10x25; 1x TX 15x25; 1x TX 20x25; 1x TX 25x25; 1x TX 27x25; 1x TX 30x25
⊖	800/1 TZ	1x 0,5x4,0x25; 1x 0,6x4,5x25
○	840/1 Z Hex-Plus	1x 2,0x25; 1x 2,5x25; 1x 3,0x25; 1x 4,0x25; 1x 5,0x25; 1x 6,0x25; 1x 8,0x25
○	842/1 Z	1x 2,5x25; 1x 3,0x25; 1x 4,0x25; 1x 5,0x25; 1x 6,0x25
	9502	1x 105,0
	9503	1x 105,0
	9513 Chain Tool	
	9512 Chain-Hook	
	9481	1x 203,0x85,0
	9480	1x 90,0x135,0
	Hook and Loop Fastener Strip 120	1x 50,0x120,0

Safe-Torque A 2 Set 1, 1/4" hexagonal, 2-12 Nm



23-piece set; in a surface-friendly, compact and extremely robust textile box. Small size and low weight for better mobility.

1 Safe-Torque A 2 torque wrench with 1/4" hexagonal socket drive, measuring range 2-12 Nm; for controlled clockwise and counterclockwise torque operation; tightening and loosening with or without torque, disengageable torque function (Torque Lock function); 72 teeth; low return angle of 5°; easy setting and saving of the desired torque value, with audible and tactile locking when the scale values are reached, slip-over release mechanism when the set torque is reached; ergonomic 2-component handle; 9 Zyklop sockets, 12 tough bits (1/4", 50 mm long), one connection part for sockets (1/4" external hexagon to 1/4" external square head)

Click-Torque A 6 Set 1, 2.5-25 Nm

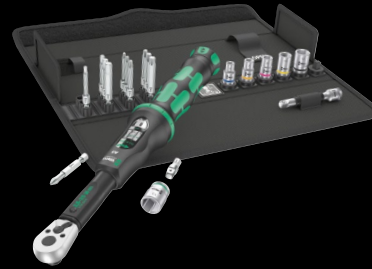

20-piece set; in a surface protecting, compact and extremely robust textile box; low volume and weight for simplified mobility.

1 Click-Torque A 6 torque wrench with 1/4" hexagon drive, covering a range of 2.5 Nm-25 Nm, accuracy ± 4% of the set value, as per DIN EN ISO 6789-1: 2017-07, for clockwise torque control, reversible ratchet, 45 teeth, easy setting and saving of the desired torque value, with audible and tactile locking when the scale values are reached (fine scale only in Newton meters), audible and tactile release mechanism when the set torque value is reached, ergonomic 2-component handle, 6 Zyklop sockets, 1 adapter 1/4" hexagon to 1/4" square, 1 Zyklop extension with free-turning sleeve, short, 11 bits

05075832001	
●	Safe-Torque A 2 1x 1/4", 2-12 Nm
●	8790 HMA 1x 5,5x23,0; 1x 6,0x23,0; 1x 7,0x23,0; 1x 8,0x23,0; 1x 9,0x23,0; 1x 10,0x23,0; 1x 11,0x23,0; 1x 12,0x23,0; 1x 13,0x23,0
○ ○	870/1 1x 1/4"x25 ¹⁾
+	851/4 Z 1x PH 2x50
⊗	867/4 Z 1x TX 10x50; 1x TX 15x50; 1x TX 20x50; TORX® 1x TX 25x50; 1x TX 27x50; 1x TX 30x50
○	840/4 Z 1x 2,5x50; 1x 3,0x50; 1x 4,0x50; 1x 5,0x50; 1x 6,0x50 ²⁾
	Hook and Loop Fastener Strip 240 1x 50,0x240,0

¹⁾ With friction ball; for manual nut spinner sockets

²⁾ Hexagonal blade

05130110001	
	Click-Torque A 6 1x 1/4", 2,5-25 Nm
+	851/4 TZ 1x PH 2x50
⊗	867/4 Z 1x TX 15x50; 1x TX 20x50; 1x TX 25x50; TORX® 1x TX 27x50; 1x TX 30x50; 1x TX 40x50
○	840/4 Z 1x 3,0x50; 1x 4,0x50; 1x 5,0x50; 1x 6,0x50 ¹⁾
○ ○	870/1 1x 1/4"x25 ²⁾
⊗ ○	8794 SA 1x 1/4"x75,0
●	8790 HMA 1x 6,0x23,0; 1x 7,0x23,0; 1x 8,0x23,0; 1x 10,0x23,0; 1x 12,0x23,0; 1x 13,0x23,0
	Hook and Loop Fastener Strip 240 1x 50,0x240,0

¹⁾ Hexagonal blade

²⁾ With friction ball; for manual nut spinner sockets

Bicycle Set 15



5-piece set

With the glass fibre reinforced plastic tyre jacks, the tyres can be safely levered off the rim without damaging the rim.

Two 9504 tyre jacks with 1/4" bit mounting

One 9505 tyre jack with valve ejector for French valves (Sclaverand) and bleeder valve for car valves

One bit 9506 (4-in-1) for hexagonal socket screws sizes 3.0; 4.0; 5.0; 6.0x37

One bit 9507 (4-in-1) for hexagonal socket screws sizes 2.5; 5.0; 6.0 and TORX® screws size TX 25

05004182001	
	9504 2x 105,0
	9505 1x 105,0
○ ○	9506 1x 3,0; 4,0; 5,0; 6,0x37
⊗ ○	9507 1x 2,5; 5,0; 6,0xTX 25x37



967/9 TX XL Multicolour HF 1 L-key set with holding function, long



9-piece set in a two-component clip

Application: TORX® socket screws

Design: Zinc-phosphated, durable plastic sleeve. The contrasting inscriptions on the colour-coded sleeves mean that it is easy to recognise the correct sizes and this makes it simpler to find the right tool.

Tip: TORX® on short arm, holding function for TORX® screws made according to Acument Intellectual Properties specifications on long arm

967/9 TX HF 1 L-key set with holding function, BlackLaser



9-piece set in a two-component clip

Application: TORX® socket screws

Design: Round

Tip: TORX® on short arm, holding function for TORX® screws made according to Acument Intellectual Properties specifications on long arm, BlackLaser surface

05024470001	
♻️	967 SXL HF TORX® Multi-colour 1x TX 8x90; 1x TX 9x101; 1x TX 10x112; 1x TX 15x123; 1x TX 20x137; 1x TX 25x154; 1x TX 27x172; 1x TX 30x195; 1x TX 40x224

05024244001	
♻️	967 L TORX® HF 1x TX 8x76; 1x TX 9x79; 1x TX 10x85; 1x TX 15x90; 1x TX 20x96; 1x TX 25x104; 1x TX 27x112; 1x TX 30x122; 1x TX 40x132

3950/9 Hex-Plus Multicolour HF Stainless 1 L-key set, metric, stainless steel, with holding function



9-piece set, in a 2-component clip

Application: Hexagonal socket screws

Design: Stainless steel, with convenient colour-coded sleeve. All L-keys are easily accessible due to their colour coding and size markings.

Tip: Hex-Plus, hexagon ball head on the long arm, from size 3.0 with holding function for hexagonal socket screws on the long arm

05022699001	
○	3950 SPKL Multicolour 1x 1,5x90; 1x 2,0x101; 1x 2,5x112
○	3950 SPKL Multicolour HF 1x 3,0x123; 1x 4,0x137; 1x 5,0x154; 1x 6,0x172; 1x 8,0x195; 1x 10,0x224

950/9 Hex-Plus Multicolour 1 L-key set, metric, BlackLaser

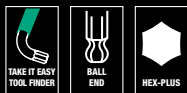

9-piece set in a two-component clip

Application: Hexagon socket screws

Design: BlackLaser surface, durable plastic sleeve. The contrasting inscriptions on the colour-coded sleeves mean that it is easy to recognise the correct sizes and this makes it simpler to find the right tool.

Tip: Hex-Plus, ball-end hexagon on long arm

05022089001	
○	950 SPKL Multicolour 1x 1,5x90; 1x 2,0x101; 1x 2,5x112; 1x 3,0x123; 1x 4,0x137; 1x 5,0x154; 1x 6,0x172; 1x 8,0x195; 1x 10,0x224

950/9 Hex-Plus Multicolour 2 L-key set, metric, BlackLaser



9-piece set in a two-component clip

Application: Hexagon socket screws

Design: BlackLaser surface, durable plastic sleeve. The contrasting inscriptions on the colour-coded sleeves mean that it is easy to recognise the correct sizes and this makes it simpler to find the right tool.

Tip: Hex-Plus, ball-end hexagon on long arm

05133164001	
○	950 SPKS Multicolour 1x 1,5x50; 1x 2,0x56; 1x 2,5x63; 1x 3,0x71; 1x 4,0x80; 1x 5,0x90; 1x 6,0x100; 1x 8,0x112; 1x 10,0x125

950/9 Hex-Plus 1 SB L-key set, metric, chrome-plated



9-piece set in a two-component clip

Application: Hexagon socket screws

Design: Chrome-plated

Tip: Hex-Plus, ball-end hexagon on long arm

05073391001	
1x 950/9 Hex-Plus 1	
○	950 PKL 1x 1.5x90; 1x 2.0x100; 1x 2.5x112; 1x 3.0x126; 1x 4.0x140; 1x 5.0x160; 1x 6.0x180; 1x 8.0x200; 1x 10.0x219

Hex-Plus



Hexagon screws can endure a problem because the contact surfaces delivering the power from the conventional tool, is transferred to the screw via very small surface areas. The consequence: the screw can become damaged (rounding out). Hex-Plus tools have a greater contact surface that prevents this from happening! At the same time, as much as 20 % more torque can be applied. Good to know: Hex-Plus tools fit into every standard hexagon socket screw!



Wera
BE A TOOL REBEL

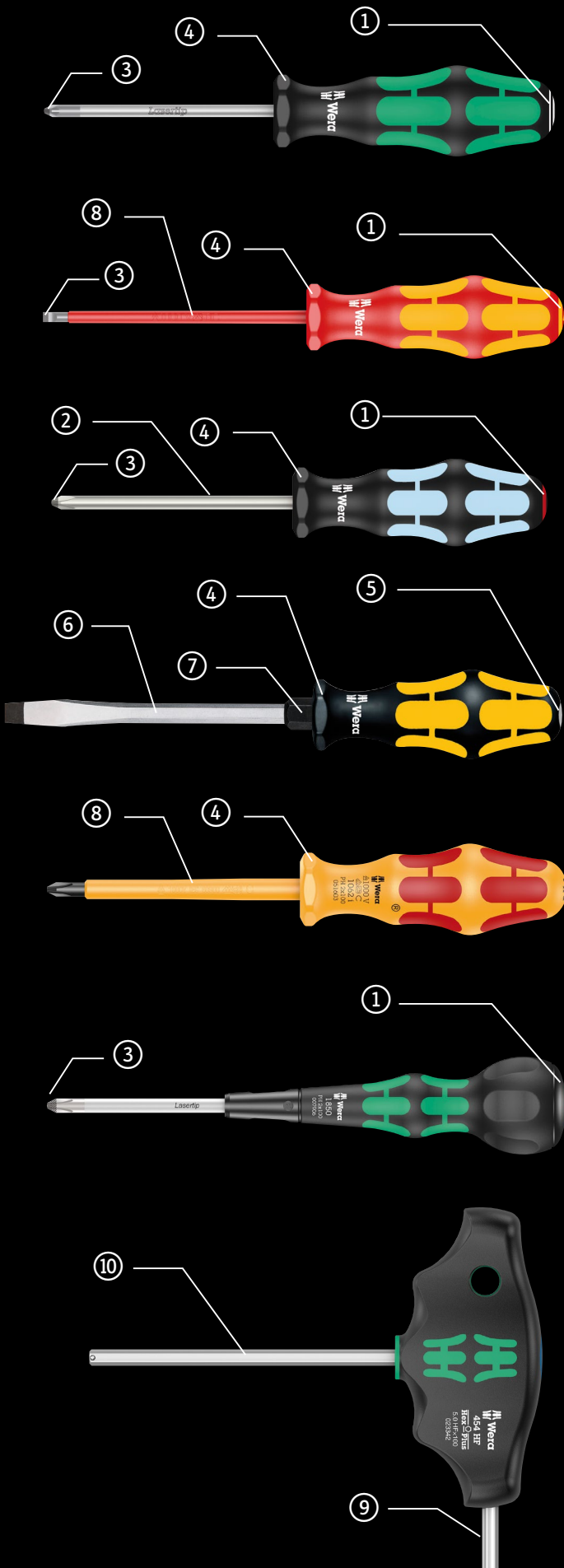

**“Take it easy”
Tool Finder**

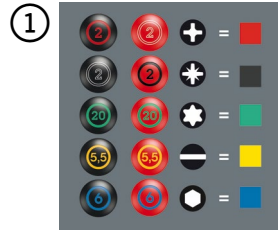

**Tools for
stainless steel**



Lasertip

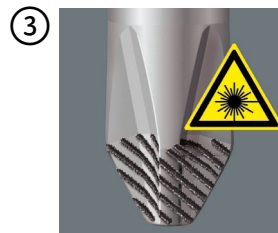

**Non-roll
feature**

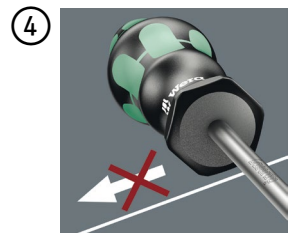

**Integrated
impact cap**



**Pound-thru
blade**



**Integrated hex
bolster**



**Individually test-
ed tool as per IEC
60900 at 10,000V**



Second arm



**High torque
transfer**

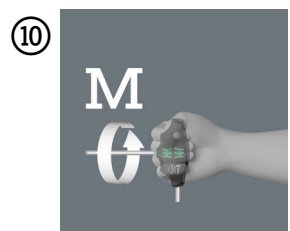

334/6 Rack Screwdriver set Kraftform Plus Lasertip and rack



Lasertip round blades and rack. Take it easy tool finder: colour coding according to profile and size stamp.

Application: Slotted and Phillips screws

Content: 6-piece set and rack in display carton

05105650001		
+	350 PH	1x PH 1x80; 1x PH 2x100
+	334	1x 1,2x6,5x150
+	335	1x 0,5x3,0x80 ¹⁾ ; 1x 0,8x4,0x100; 1x 1,0x5,5x125

¹⁾ without Lasertip

Kraftform Big Pack 300



Kraftform Plus – Series 300. With Lasertip blade and rack. Take it easy tool finder: colour coding according to profile and size stamp.

Application: Slotted, cross, Phillips, Pozidriv and TORX® screws

Content: 14-piece set in display carton

05105630001		
+	350 PH	1x PH 1x80; 1x PH 2x100; 1x PH 3x150
+	355 PZ	1x PZ 1x80; 1x PZ 2x100; 1x PZ 3x150
+	367 TORX®	1x TX 10x80; 1x TX 15x80; 1x TX 20x100; 1x TX 25x100; 1x TX 30x115
+	334	1x 1,2x6,5x150
+	335	1x 0,6x3,5x100 ¹⁾ ; 1x 0,8x4,0x100
	Rack for Kraftform screwdrivers	2x 190,0x50,0

¹⁾ without Lasertip

Operation of tension spring terminals



Terminal blocks hold the wire ends mechanically. The force required for this is applied by a spring in the case of tension spring terminals. The spring must be opened by a tool in order to be able to insert the wire ends. The special actuation tools from Wera allow operating the tension spring terminals – even in tight spaces such as switch cabinets. The curved blade also allows spring terminals to be reached where straight-blade tools cannot be used.

338/2 Set of actuation tools for terminal blocks (spring cages)



Application: Unlocking contact springs in electrotechnical line terminals; for spring terminals with a conductor cross-section of up to 1.5 mm² and 2.5 to 4.0 mm²

Blade: Round, plastic coated, curved by 30°

Handle: Kraftform with anti-roll protection, multi-component

Design: 2-piece set in a box

05008100001		
+	338	1x 0,4x2,5x81; 1x 0,6x3,5x81



Lasertip



A precisely-focused laser creates a sharp-edged surface structure. This laser treatment results in an edge hardness of up to 1000 HV 0.3. Wera Lasertip “bites” itself into the screw head and prevents any slips out of the recess. It is available for screwdrivers for slotted, Phillips and Pozidriv screws.

160 i/7 Rack Screwdriver set Kraftform Plus Series 100, single-pole phase tester and rack

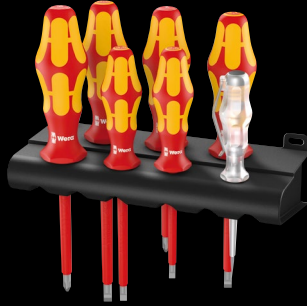

Kraftform: The safety screwdriver with Lasertip blade, single-pole phase tester and rack. Take it easy tool finder: colour coding according to profile and size stamp.

Application: Slotted and Phillips screws

Content: 7-piece set and rack in display carton

05006147001	
+	162 i VDE PH 1x PH 1x80; 1x PH 2x100
-	160 i VDE 1x 0,4x2,5x80 ¹⁾ ; 1x 0,6x3,5x100 ¹⁾ ; 1x 0,8x4,0x100; 1x 1,0x5,5x125
-	247 1x 0,5x3,0x70

¹⁾ without Lasertip

²⁾ Product not available in the USA and Canada.

Kraftform Big Pack 100 VDE

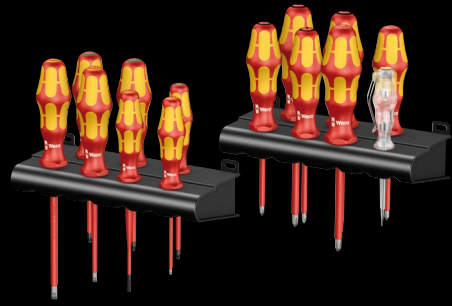

Kraftform: The safety screwdriver with Lasertip blade, single-pole phase tester and rack. Take it easy tool finder: colour coding according to profile and size stamp.

Application: Slotted, Phillips, PlusMinus (Pozidriv/slotted), Pozidriv and TORX® screws

Content: 14-piece set in display carton

05105631001	
+	162 i VDE PH 1x PH 1x80; 1x PH 2x100
+	165 i PZ VDE 1x PZ 1x80; 1x PZ 2x100
+	165 i PZ/S VDE 1x # 1x80; 1x # 2x100
+	167 i TORX® VDE 1x TX 10x80; 1x TX 15x80; 1x TX 20x80
-	160 iS VDE 1x 0,6x3,5x100
-	160 i VDE 1x 0,4x2,5x80 ¹⁾ ; 1x 0,8x4,0x100; 1x 1,0x5,5x125
-	247 1x 0,5x3,0x70
	Rack for Kraftform screwdrivers 2x 190,0x50,0

¹⁾ without Lasertip

²⁾ Product not available in the USA and Canada.

1060 i/1062 i/6 Kraftform VDE screwdriver set



Application: Slotted and Phillips-head screws Phillips-Recess

Design: 6-piece set

05051575001	
+	1062 i PH VDE 1x PH 1x80; 1x PH 2x100
-	1060 i VDE 1x 0,4x2,5x80; 1x 0,6x3,5x100; 1x 0,8x4,0x100; 1x 1,0x5,5x125



Individually tested



The individual testing at 10,000 volts, in accordance with IEC 60900, ensures safe working with loads up to 1,000 volts.

932/6 Screwdriver set Kraffform Wera: Chiseldriver and rack



Application: Slotted and Phillips screws

Content: 6-piece set and rack in display carton

05018282001		
+	917 SPH	1x PH 1x80; 1x PH 2x100
-	932 A	1x 0,6x3,5x80 ¹⁾ ; 1x 0,8x4,5x90; 1x 1,0x5,5x100; 1x 1,2x7,0x125

¹⁾ No throughout blade, no impact cap and no hexagon bolster

Big Pack 900 Screwdriver set Kraffform Wera: Chiseldriver and rack



Application: Slotted, Phillips, Pozidriv and TORX® socket screws

Content: 13-piece set

05133285001		
+	917 SPH	1x PH 1x80; 1x PH 2x100; 1x PH 3x150
+	918 SPZ	1x PZ 1x80; 1x PZ 2x100; 1x PZ 3x150
-	932 A	1x 0,6x3,5x80 ¹⁾ ; 1x 0,8x4,5x90; 1x 1,0x5,5x100; 1x 1,2x7,0x125; 1x 1,6x9,0x150
+	977 TORX®	1x TX 20x90; 1x TX 25x100
	Rack for Kraffform screwdrivers	2x 190,0x50,0

¹⁾ No throughout blade, no impact cap and no hexagon bolster



Integrated impact cap

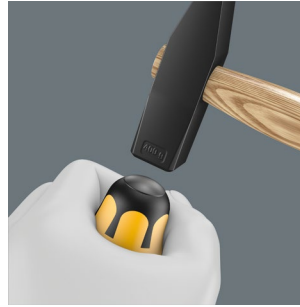

An integrated impact cap lengthens the service life and reduces the danger of splintering. Nevertheless, always wear protective goggles.



Pound-thru blade



A hexagon blade made out of high-quality bit material extends right through the handle – thereby ensuring full transfer of force, even when struck with a hammer. The ductile tempered material prevents the blade from splintering or breaking.



Integrated hex bolster



Greater torque can be transferred by fitting an open-jaw or ring spanner over the integrated hex bolster.



Wera Black Point tip



The Wera Black Point tip and a refined hardening process ensure long service life of the tip, improved corrosion protection and an exact fit.

454/7 HF Set 1 screwdriver set T-handle screwdrivers Hex-Plus with holding function

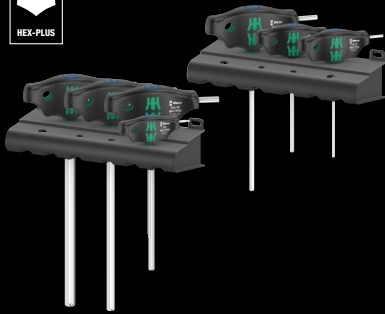

Application: Hexagon socket screws, with holding function on the long arm from size 3

Design: With Take it easy tool finder: colour coding according to profile (blue = hexagon socket) and size stamp. 7-piece set and 2 racks in display carton

05023450001		
○ 454	1x 2,5x100	
○ 454 HF	1x 3x100; 1x 4x100; 1x 5x150; 1x 6x150; 1x 8x200; 1x 10x200	
Rack for Kraftform screwdrivers	2x 190,0x50,0	

Ergonomic 2-component T-handle



The ergonomically shaped 2-component T-handle with finger recesses and pleasant surface facilitates very high power transmission and fatigue-free working.



TORX® HF profile

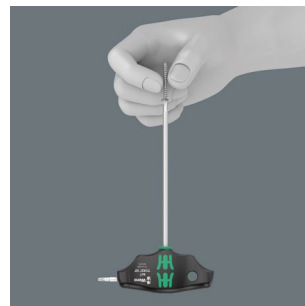

In tight assembly or disassembly situations, for example in engine compartments, it is not possible to securely hold the screw with the hand on the screwdriver, and the screw subsequently often gets lost. Lengthy searches or the loss of the screw (with the associated danger that could bring about)

are the consequence. The HF tools developed by Wera are ideal because they feature an optimised geometry of the original TORX® profile. The wedging forces resulting from the surface pressure between the drive tip and the screw profile mean that the screw is securely held on the tool!

“Take it easy” Tool Finder

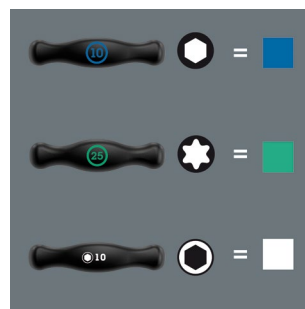

Screwdrivers with “Take it easy” tool finder: colour coding according to profile and size stamp.





Kraftform Micro 12 Universal 1 screwdriver set for electronic applications

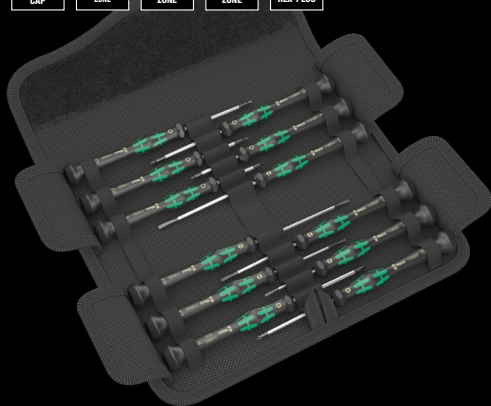

Take it easy tool finder: colour coding according to profile and size stamp.

Application: Slotted, Phillips, TORX® and hexagon socket screws

Content: 12-piece set, in a belt pouch

05073675001		
+	2050 Micro	1x PH 00x60 ¹⁾ ; 1x PH 0x60 ²⁾
T	2067 TORX® HF	1x TX 5x40; 1x TX 6x40
-	2035 Micro	1x 0,23x1,5x40; 1x 0,30x1,8x60; 1x 0,40x2,0x60; 1x 0,40x2,5x80; 1x 0,50x3,0x80
0	2054 Micro	1x 0,9x40; 1x 1,5x60; 1x 2x60
	Hook and Loop Fastener Strip 70	1x 50,0x70,0

¹⁾ Optimised for Asian PH screws

²⁾ Size 0 modified according to JClS 0 (Japanese Camera Industrial Standard)



“Take it easy” Tool Finder

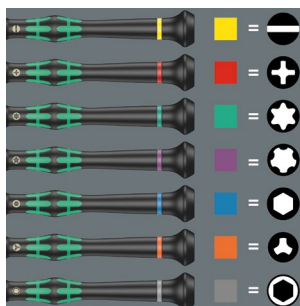

Screwdrivers with “Take it easy” tool finder: colour coding according to profile and size stamp.



The refined screwdriver for electronics technicians



The Kraftform Micro, with its three zones and their specific arrangement, satisfies these requirements perfectly. The free-turning cap that provides support for the hand works with these advantages, enabling quick and easy precision work.

Kraftform Micro Big Pack 1 screwdriver set for electronic applications



Take it easy tool finder: colour coding according to profile and size stamp.

Application: Slotted screws, Phillips-head, Phillips-Recess, TORX® (TX 5, TX 6, TX 7, TX 8, TX 10 with holding function), TORX PLUS® IPR, internal and external hex and Microstix® screws, 1 chip lifter to remove stuck components on circuit boards after soldering

Design: 25 pieces; in roll pouch; suitable for Wera 2go

05134000001	
+	2050 Micro 1x PH 000x40 ¹ 2; 1x PH 00x40 ¹ 2; 1x PH 0x40 ³
+	2067 TORX® Micro 1x TX 5x40; 1x TX 6x40
+	2067 TORX® HF 1x TX 5x40; 1x TX 6x40; 1x TX 7x60; 1x TX 8x60; 1x TX 10x60
+	2067 TORX PLUS® IPR Micro 1x 1 IPRx40 ⁴
○	2054 Micro 1x 0,9x40; 1x 1,3x40; 1x 1,5x60; 1x 2x60
●	2035 Micro 1x 0,23x1,5x40; 1x 0,30x1,8x60; 1x 0,35x2,5x40; 1x 0,40x2,0x60; 1x 0,40x2,5x80; 1x 0,50x3,0x80
●	2069 Micro 1x 4,0x60; 1x 5,5x60
●	2072 Micro 1x mx40
●	1429 1x 1,0x3,5x50
	Hook and Loop Fastener Strip 240 1x 50,0x240,0

¹ Optimised for Asian PH screws

² On the output side, the blade is turned to a nominal length of 10 mm

³ Size 0 modified according to JGIS 0 (Japanese Camera Industrial Standard)

⁴ Without bore hole

2035/6 A Screwdriver set and rack for electronic applications

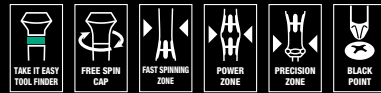

Take it easy tool finder: colour coding according to profile and size stamp.

Application: Slotted and Phillips screws

Content: 6-piece set and rack in display carton

05118150001	
+	2050 Micro 1x PH 00x60 ¹ ; 1x PH 0x60 ²
●	2035 Micro 1x 0,30x1,8x60; 1x 0,40x2,0x60; 1x 0,40x2,5x80; 1x 0,50x3,0x80

¹ Optimised for Asian PH screws

² Size 0 modified according to JGIS 0 (Japanese Camera Industrial Standard)

Kraftform Kompakt Micro 11 Universal 1



11-piece set

Pouch with 44 mm bits

1 Kraftform Micro bitholding screwdriver 1013

05135938001	
●	1013 Kraftform Micro 1x 97
+	851/9 C 1x PH 00x44x1,8 ¹ ; 1x PH 0x44x2,2 ² ; 1x PH 1x44x3,0 ¹
○	840/9 C 1x 1,5x44; 1x 2,0x44
●	800/9 C 1x 0,23x1,5x44; 1x 0,40x2,0x44; 1x 0,50x3,0x44
+	867/9 C TORX® 1x TX 5x44; 1x TX 6x44

¹ Optimised for Asian PH screws

² Size 0 modified according to JGIS 0 (Japanese Camera Industrial Standard)



Slide-over mechanism prevents application of excessive torques

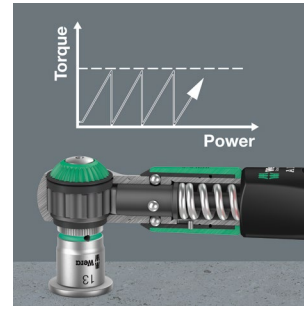

The Safe-Torque torque wrench is equipped with a slide-over mechanism. Once the set torque value has been reached, the tool cannot be overtightened, so that excessive torque cannot be applied.

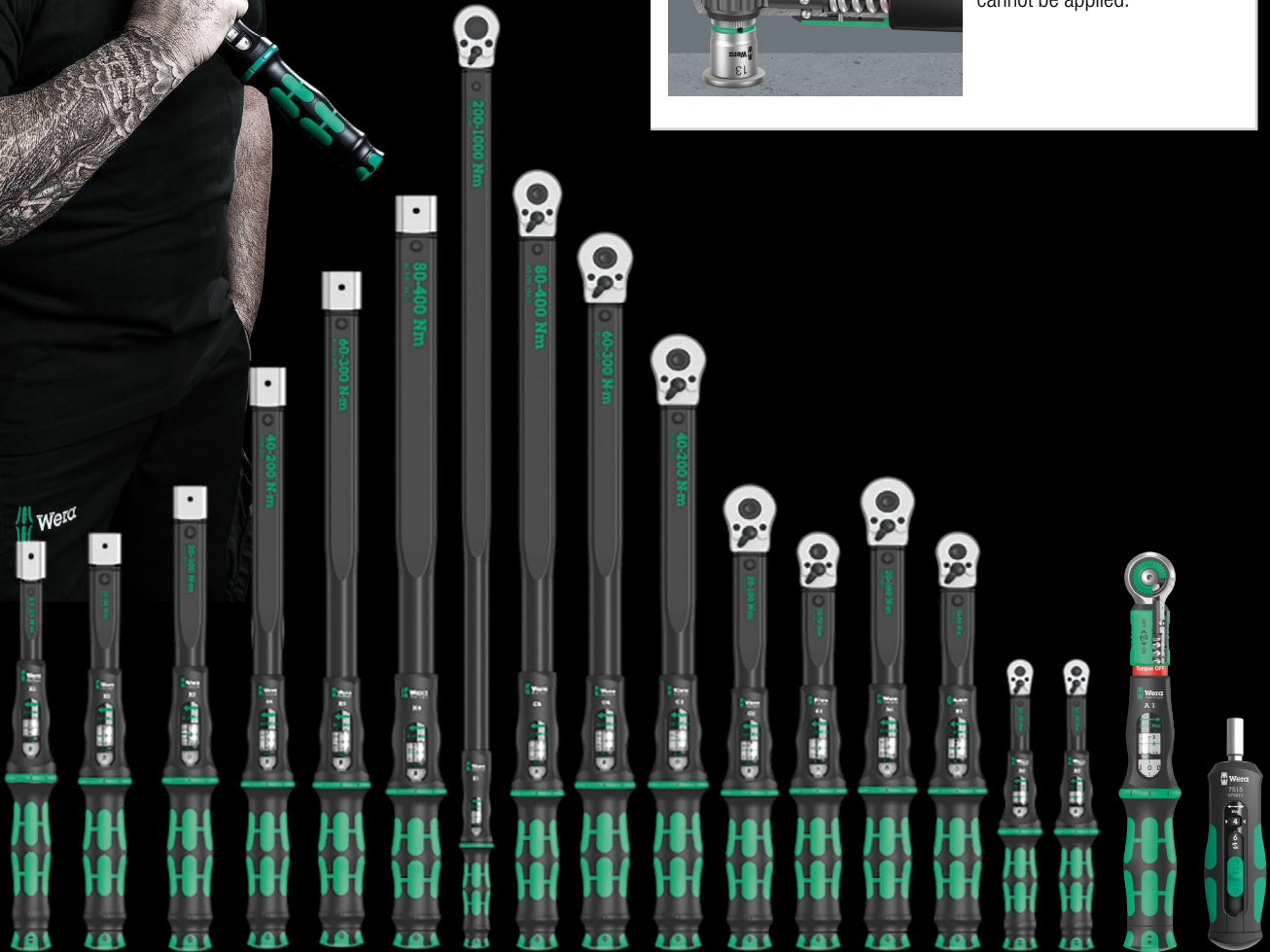

Safe-Torque A 1 torque wrench with 1/4" square head drive, 2-12 Nm

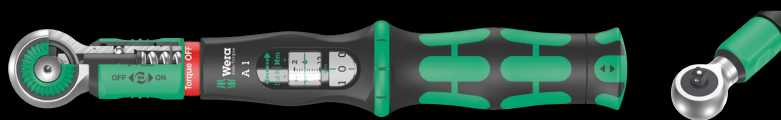

Application: For controlled clockwise and counterclockwise torque operation; tightening and loosening with or without torque

Torque range: 2-12 Nm

Suitable for: 1/4" sockets

Precision: Accuracy ± 10 % of the set value

Design: With 1/4" square head drive, torque wrench, disengageable torque function (Torque Lock function); 72 teeth; low return angle of 5°; easy setting and saving of the desired torque value, with audible and tactile locking when the scale values are reached, slip-over release mechanism when the set torque is reached

Handle: Ergonomic 2-component handle

		Nm	Nm	lbf. ft.	mm	mm	mm	mm	mm	mm	mm	mm	mm	
05075800001	1/4"	2-12	0,10	2-9	244	94	38,5	31,6	23,7	9 3/64"	3 45/64"	1 33/64"	1 11/64"	15/16"

Safe-Torque A 2 torque wrench with 1/4" hexagon drive, 2-12 Nm

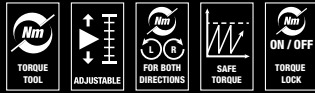

Application: For controlled clockwise and counterclockwise torque operation; tightening and loosening with or without torque

Torque range: 2-12 Nm

Suitable for: 1/4" bits with 1/4" external hexagon drive as per DIN ISO 1173-C 6.3 and E 6.3 and Wera connection series 1 and 4

Precision: Accuracy ± 10 % of the set value

Design: With 1/4" hexagonal drive, torque wrench, disengageable torque function (Torque Lock function); 72 teeth; low return angle of 5°; easy setting and saving of the desired torque value, with audible and tactile locking when the scale values are reached, slip-over release mechanism when the set torque is reached

Handle: Ergonomic 2-component handle

		Nm	Nm	lbf. ft.	mm	mm	mm	mm	mm	mm	mm	mm	mm	mm
05075801001	1/4"	2-12	0,10	2-9	244	94	38,5	31,6	23,7	9 3/64"	3 45/64"	1 33/64"	1 15/64"	15/16"

Safe-Torque A 1 Set 1, 1/4" square head drive, 2-12 Nm



10-piece set; in a surface-friendly, compact and extremely robust textile box. Small size and low weight for better mobility.

1 Safe-Torque A 1 torque wrench with 1/4" square head drive, measuring range 2-12 Nm; for controlled clockwise and counterclockwise torque operation; tightening and loosening with or without torque, disengageable torque function (Torque Lock function); 72 teeth; low return angle of 5°; easy setting and saving of the desired torque value, with audible and tactile locking when the scale values are reached, slip-over release mechanism when the set torque is reached; ergonomic 2-component handle; 8 Zyklop sockets, one Zyklop extension with fast-rotating sleeve, short

05075830001			
○	Safe-Torque A 1	1x 1/4", 2-12 Nm	
●	8790 HMA	1x 5,5x23,0; 1x 6,0x23,0; 1x 7,0x23,0; 1x 8,0x23,0; 1x 10,0x23,0; 1x 11,0x23,0; 1x 12,0x23,0; 1x 13,0x23,0	
○	8794 SA	1x 1/4"x75,0	
	Hook and Loop Fastener Strip 240	1x 50,0x240,0	

Safe-Torque A 2 Set 1, 1/4" hexagonal, 2-12 Nm



23-piece set; in a surface-friendly, compact and extremely robust textile box. Small size and low weight for better mobility.

1 Safe-Torque A 2 torque wrench with 1/4" hexagonal drive, measuring range 2-12 Nm; for controlled clockwise and counterclockwise torque operation; tightening and loosening with or without torque, disengageable torque function (Torque Lock function); 72 teeth; low return angle of 5°; easy setting and saving of the desired torque value, with audible and tactile locking when the scale values are reached, slip-over release mechanism when the set torque is reached; ergonomic 2-component handle; 9 Zyklop sockets, 12 tough bits (1/4", 50 mm long), one connection part for sockets (1/4" external hexagon to 1/4" external square head)

05075832001			
○	Safe-Torque A 2	1x 1/4", 2-12 Nm	
●	8790 HMA	1x 5,5x23,0; 1x 6,0x23,0; 1x 7,0x23,0; 1x 8,0x23,0; 1x 9,0x23,0; 1x 10,0x23,0; 1x 11,0x23,0; 1x 12,0x23,0; 1x 13,0x23,0	
○	870/1	1x 1/4"x25 ¹⁾	
+	851/4 Z	1x PH 2x50	
+	867/4 Z TORX®	1x TX 10x50; 1x TX 15x50; 1x TX 20x50; 1x TX 25x50; 1x TX 27x50; 1x TX 30x50	
○	840/4 Z	1x 2,5x50; 1x 3,0x50; 1x 4,0x50; 1x 5,0x50; 1x 6,0x50 ²⁾	
	Hook and Loop Fastener Strip 240	1x 50,0x240,0	

¹⁾ With friction ball; for manual nut spinner sockets

²⁾ Hexagonal blade

Click-Torque A 5 torque wrench with reversible ratchet, 2.5-25 Nm

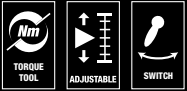

Application: For clockwise torque-control

Precision: ± 4% of set value, as per DIN EN ISO 6789-1: 2017-07

Design: With 1/4" square drive, reversible ratchet, 45 teeth; easy setting and saving of the desired torque value, with audible and tactile locking when the scale values are reached (fine scale only in Newton meters), audible and tactile release mechanism when the set torque value is reached

Handle: Ergonomic 2-component handle

	Nm Nm	lbf. ft.	mm	mm	mm	mm	mm	mm	mm	mm	mm	mm	mm
05075604001	1/4"	2,5-25 0,10	1-18	290	121	42	25	11,5	11 27/64"	4 49/64"	1 29/32"	1"	7/16"

Click-Torque A 6 torque wrench with reversible ratchet, 2.5-25 Nm



Application: For clockwise torque-control

Precision: ± 4% of set value, as per DIN EN ISO 6789-1: 2017-07

Design: With 1/4" hex drive, reversible ratchet, 45 teeth; easy setting and saving of the desired torque value, with audible and tactile locking when the scale values are reached (fine scale only in Newton meters), audible and tactile release mechanism when the set torque value is reached

Handle: Ergonomic 2-component handle

	Nm Nm	lbf. ft.	mm	mm	mm	mm	mm	mm	mm	mm	mm	mm	mm
05075605001	1/4"	2,5-25 0,10	1-18	290	121	42	25	11,5	11 27/64"	4 49/64"	1 29/32"	1"	7/16"

Click-Torque A 6



With 1/4" hex drive.

Release mechanism

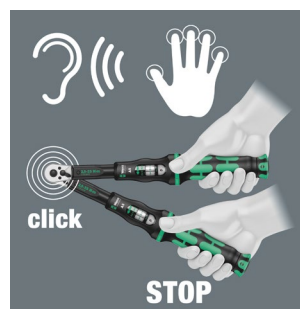

When the set torque value is reached, an audible and tactile mechanism triggers.

Click-Torque B 1 torque wrench with reversible ratchet, 10-50 Nm

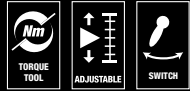

Application: For clockwise torque-control

Precision: ± 3% of set value, as per DIN EN ISO 6789-1: 2017-07

Design: With 3/8" square drive, reversible ratchet, 45 teeth; easy setting and saving of the desired torque value, with audible and tactile locking when the scale values are reached (fine scale only in Newton meters), audible and tactile release mechanism when the set torque value is reached

Handle: Ergonomic 2-component handle

		Nm	Nm	lbf. ft.	mm	mm	mm	mm	mm	mm	mm	mm	mm	
05075610001	3/8"	10-50	0,25	8-36	360	140	47	35	16,5	14 11/64"	5 33/64"	1 27/32"	1 3/8"	5/8"

Click-Torque B 2 torque wrench with reversible ratchet, 20-100 Nm

		Nm	Nm	lbf. ft.	mm	mm	mm	mm	mm	mm	mm	mm	mm	
05075611001	3/8"	20-100	0,5	15-73	405	140	47	43	18,5	15 15/16"	5 33/64"	1 27/32"	1 11/16"	5/64"

Click-Torque C 1 torque wrench with reversible ratchet, 10-50 Nm

		Nm	Nm	lbf. ft.	mm	mm	mm	mm	mm	mm	mm	mm	mm	
05075620001	1/2"	10-50	0,25	8-36	360	140	47	35	16,5	14 11/64"	5 33/64"	1 27/32"	1 3/8"	5/8"

Click-Torque C 2 torque wrench with reversible ratchet, 20-100 Nm

		Nm	Nm	lbf. ft.	mm	mm	mm	mm	mm	mm	mm	mm	mm	
05075621001	1/2"	20-100	0,5	15-73	405	140	47	43	18,5	15 15/16"	5 33/64"	1 27/32"	1 11/16"	5/64"

Click-Torque C 3 torque wrench with reversible ratchet, 40-200 Nm

		Nm	Nm	lbf. ft.	mm	mm	mm	mm	mm	mm	mm	mm	mm	
05075622001	1/2"	40-200	1,0	30-146	510	140	47	43	18,5	20 5/64"	5 33/64"	1 27/32"	1 11/16"	5/64"

Click-Torque C 4 torque wrench with reversible ratchet, 60-300 Nm

		Nm	Nm	lbf. ft.	mm	mm	mm	mm	mm	mm	mm	mm	mm	
05075623001	1/2"	60-300	1,0	45-220	595	140	47	43	18,5	23 27/64"	5 33/64"	1 27/32"	1 11/16"	5/64"

Simple setting



With audible and tactile clicks when adjusting the scale values.

Simple and safe

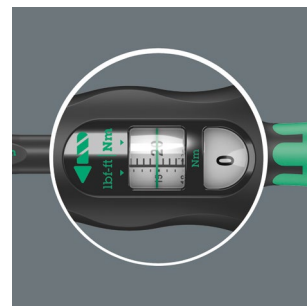

Easy setting and saving of the desired torque value; readable on the main and fine scales.

Click-Torque C 2 Push R/L adjustable torque wrench for clockwise and anti-clockwise torque-control, 20-100 Nm

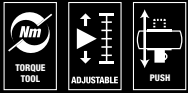

Application: For clockwise and anti-clockwise torque-control

Precision: Precise to $\pm 3\%$ of the set value, as per DIN EN ISO 6789-1:2017-07

Design: With $\frac{1}{2}$ " square head drive with socket locking, square head insert to change the tightening direction, fine-teethed ratchet mechanics, 45 teeth; easy setting and saving of the desired torque, with audible and tactile locking when the scale values are reached (fine scale only in Newton meters), audible and tactile release mechanism when the torque value is reached

Handle: Ergonomic 2-component handle

		Nm		lbf. ft.	mm	mm	mm	mm	mm	mm	mm	mm	mm	
05075625001	$\frac{1}{2}$ "	20-100	0,5	15-73	405	140	47	43	18,5	15 $\frac{15}{16}$ "	5 $\frac{39}{64}$ "	1 $\frac{27}{32}$ "	1 $\frac{11}{16}$ "	$\frac{45}{64}$ "

Click-Torque C 3 Push R/L adjustable torque wrench for clockwise and anti-clockwise torque-control, 40-200 Nm

		Nm		lbf. ft.	mm	mm	mm	mm	mm	mm	mm	mm	mm	
05075626001	$\frac{1}{2}$ "	40-200	1,0	30-146	510	140	47	43	18,5	20 $\frac{5}{64}$ "	5 $\frac{39}{64}$ "	1 $\frac{27}{32}$ "	1 $\frac{11}{16}$ "	$\frac{45}{64}$ "

Click-Torque E 1 Push R/L adjustable torque wrench for clockwise and anti-clockwise torque-control, 200-1000 Nm

		Nm		lbf. ft.	mm	mm	mm	mm	mm	mm	mm	mm	mm	
05075631001	$\frac{3}{4}$ "	200-1000	1,0	148-737	1250	140	47	63	30	49 $\frac{7}{32}$ "	5 $\frac{39}{64}$ "	1 $\frac{27}{32}$ "	2 $\frac{31}{64}$ "	1 $\frac{3}{16}$ "

Series 7400 Kraftform adjustable torque screwdrivers (0.1-3.0 Nm) with Rapidaptor quick-release chuck



Application: Suitable for $\frac{1}{4}$ " DIN ISO 1173-C 6.3 and E 6.3 hexagon insert bits and Wera Series 1 and 4

Design: Rapidaptor rapid-in, rapid-out, rapid-spin, chuck-all and single-hand technology

Accuracy: $\pm 6\%$ (DIN EN ISO 6789). Numerical torque valuescale. Reliable slipping mechanism and acoustic signal when reaching the set torque.

Handle: Kraftform with non-roll feature, multi-component

			Nm		mm	mm	mm
05074770001 ¹⁾	7430	$\frac{1}{4}$ "	0,10-0,34	0,015	89	142	5 $\frac{7}{16}$ "
05074772001 ¹⁾	7431	$\frac{1}{4}$ "	0,30-1,00	0,05	89	142	5 $\frac{7}{16}$ "
05074774001 ¹⁾	7432	$\frac{1}{4}$ "	0,90-1,50	0,05	89	142	5 $\frac{7}{16}$ "
05074700001	7440	$\frac{1}{4}$ "	0,3-1,2	0,05	105	155	6"
05074701001	7441	$\frac{1}{4}$ "	1,2-3,0	0,10	105	155	6"

Series 7400 Kraftform pistol handle, adjustable torque screwdrivers (3.0-8.8 Nm) with Rapidaptor quick-release chuck

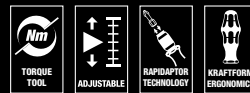

Application: Suitable for $\frac{1}{4}$ " DIN ISO 1173-C 6.3 and E 6.3 hexagon insert bits and Wera Series 1 and 4

Design: Rapidaptor rapid-in, rapid-out, rapid-spin, chuck-all and single-hand technology

Accuracy: $\pm 6\%$ (DIN EN ISO 6789). Numerical torque value scale. Reliable slipping mechanism and acoustic signal when reaching the set torque.

Handle: Kraftform pistol grip, multi-component

			Nm		mm	mm	mm
05074702001	7442	$\frac{1}{4}$ "	3,0-6,0	0,25	150	100	4"
05074705001	7443	$\frac{1}{4}$ "	4,0-8,8	0,40	150	100	4"

¹⁾ With attachable magnifying glass, significantly improving readability.

7400 series Kraftform Torque screwdrivers, with factory pre-set value (0.3-3.0 Nm) and Rapidaptor quick-release chuck, handle size 105 mm



- Application:** Suitable for 1/4" DIN ISO 1173-C 6.3 and E 6.3 hexagon insert bits and Wera Series 1 and 4
- Design:** Rapidaptor rapid-in, rapid-out, rapid-spin, chuck-all and single-hand technology
- Pre-set torque:** 0.3 Nm, 1.2 Nm
- Accuracy:** ± 6% (DIN EN ISO 6789). Reliable slipping mechanism and acoustic signal when reaching the set torque.
- Handle:** Kraftform with non-roll feature, multi-component

	Art.No.						
	Art.No.	Nm	Nm	mm	mm	mm	mm
05074715001 ¹⁾	7460	1/4"	0,3	0,3-1,2	105	155	6"
05074716001 ¹⁾	7461	1/4"	1,2	1,2-3,0	105	155	6"

¹⁾ The preset torque can be changed. However, this requires the use of special tools and Torque Test Equipment. Please contact the Wera Torque Service.

7400 series Kraftform Torque screwdrivers, with factory pre-set value (0.1-1.5 Nm) and Rapidaptor quick-release chuck, handle size 89 mm



- Application:** Suitable for 1/4" DIN ISO 1173-C 6.3 and E 6.3 hexagon insert bits and Wera Series 1 and 4
- Design:** Rapidaptor rapid-in, rapid-out, rapid-spin, chuck-all and single-hand technology
- Pre-set torque:** 0.1 Nm, 0.3 Nm, 0.9 Nm
- Accuracy:** ± 6% (DIN EN ISO 6789). Reliable slipping mechanism and acoustic signal when reaching the set torque.
- Handle:** Kraftform with non-roll feature, multi-component

	Art.No.						
	Art.No.	Nm	Nm	mm	mm	mm	mm
05074790001 ¹⁾	7450	1/4"	0,1	0,1-0,34	89	133	5 1/4"
05074792001 ¹⁾	7451	1/4"	0,3	0,3-1,0	89	133	5 1/4"
05074794001 ¹⁾	7452	1/4"	0,9	0,9-1,5	89	133	5 1/4"

¹⁾ The preset torque can be changed. However, this requires the use of special tools and Torque Test Equipment. Please contact the Wera Torque Service.

Series 7400 Kraftform torque screwdrivers with a customised factory pre-set measurement value, handle size 105 mm



	Art.No.					
	Art.No.	Nm	mm	mm	mm	mm
05074715010	7460	1/4"	0,3-1,2	105	155	6"
05074716010	7461	1/4"	1,2-3,0	105	155	6"

¹⁾ The desired settings can be made in the following units: Nm, kgf. m, lbf. ft., ozf. in., dN. m, kgf. cm, lbf. in, in. oz, cN. m, gf. m, ft. lb, gf. cm, in. lb.

Series 7400 Kraftform torque screwdrivers with a customised factory pre-set measurement value, handle size 89 mm



	Art.No.					
	Art.No.	Nm	mm	mm	mm	mm
05074790010	7450	1/4"	0,1-0,34	89	133	5 1/4"
05074792010	7451	1/4"	0,3-1,0	89	133	5 1/4"
05074794010	7452	1/4"	0,9-1,5	89	133	5 1/4"

¹⁾ The desired settings can be made in the following units: Nm, kgf. m, lbf. ft., ozf. in., dN. m, kgf. cm, lbf. in, in. oz, cN. m, gf. m, ft. lb, gf. cm, in. lb.

7400 series Kraftform Torque screwdrivers, with factory pre-set value (3.0-8.8 Nm) and Rapidaptor quick-release chuck, pistol handle

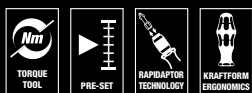

- Application:** Suitable for 1/4" DIN ISO 1173-C 6.3 and E 6.3 hexagon insert bits and Wera Series 1 and 4
- Design:** Rapidaptor rapid-in, rapid-out, rapid-spin, chuck-all and single-hand technology
- Pre-set torque:** 3.0 Nm, 4.0 Nm
- Accuracy:** ±6 % (DIN EN ISO 6789). Reliable slipping mechanism and acoustic signal when reaching the set torque.
- Handle:** Kraftform pistol grip, multi-component

	Art.No.	Nm	Nm	mm	mm	mm	mm
05074717001 ^{b)}	7462	1/4"	3,0	3,0-6,0	150	100	6"
05074728001 ^{b)}	7463	1/4"	4,0	4,0-8,8	150	100	6"

^{b)} The preset torque can be changed. However, this requires the use of special tools and Torque Test Equipment. Please contact the Wera Torque Service.

Series 7400 Kraftform torque screwdrivers with a customised factory pre-set measurement value, pistol handle

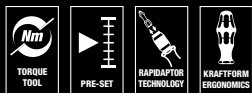

- Application:** Suitable for 1/4" DIN ISO 1173-C 6.3 and E 6.3 hexagon insert bits and Wera Series 1 and 4
- Design:** Rapidaptor rapid-in, rapid-out, rapid-spin, chuck-all and single-hand technology
- Pre-set torque:** Adjustable to customer requirements within the specified measurement range
- Accuracy:** ±6 % (DIN EN ISO 6789). Reliable slipping mechanism and acoustic signal when reaching the set torque.
- Handle:** Kraftform pistol grip, multi-component

	Art.No.	Nm	mm	mm	mm	mm
05074717010	7462	1/4"	3,0-6,0	150	100	6"
05074728010	7463	1/4"	4,0-8,8	150	100	6"

^{b)} The desired settings can be made in the following units: Nm, kgf. m, lbf. ft., ozf. in., dN. m, kgf. cm, lbf. in, in. oz, cN. m, gf. m, ft. lb, gf. cm, in. lb.

7515 Kraftform Safe-Torque Speed Torque screwdriver, 2-6 Nm

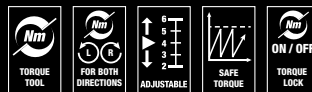

- Application:** Suitable for bits with 1/4" external hexagon drive
- Design:** Five selectable maximum tightening torques and one fixed position; bit mounting with ±10 % precision. Digital torque value display. Reliable signal when the set torque is reached.
- Handle:** Kraftform, multi-component

	Nm	Nm	Nm	Nm	Nm	mm
05075815001	1/4"	2,0	3,0	4,0	5,0	6,0

7510 Kraftform Safe-Torque Speed Torque screwdriver, 1-3 Nm



- Application:** Suitable for bits with 1/4" external hexagon drive
- Design:** Five selectable maximum tightening torques and one fixed position; bit mounting with ±10 % precision. Digital torque value display. Reliable signal when the set torque is reached.
- Handle:** Kraftform, multi-component

	Nm	Nm	Nm	Nm	Nm	mm
05075810001	1/4"	1,0	1,5	2,0	2,5	3,0

7515/7 Kraftform Safe-Torque Speed Bicycle 1

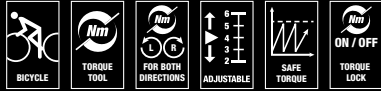

7-piece set

Folding pouch with one torque screwdriver 7515 with easy quick torque setting and 6 tough bits (50 mm length), with Wera "Take it easy" Tool finder: size stamping and colour coding by output to help you find the required bit easily



05075850001	
7515	1x 1/4"x2,0 Nm; 3,0 Nm; 4,0 Nm; 5,0 Nm; 6,0 Nm x147,5
⊕	867/4 TORX® BTZ 1x TX 10x50; 1x TX 25x50
○	840/4 BTZ 1x 2,5x50; 1x 3,0x50; 1x 4,0x50; 1x 5,0x50

7515/16 Kraftform Safe-Torque Speed Universal 1

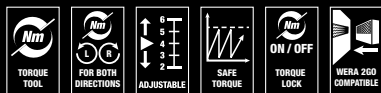

Five selectable tightening torques



Five selectable tightening torques (7510: 1.0; 1.5; 2.0; 2.5; 3.0 Nm; 7515: 2.0; 3.0; 4.0; 5.0; 6.0 Nm) and one fixed position (Torque Lock) for unlimited tightening and loosening moments.

Simple setting



Easy setting of the selectable tightening torques.

Excess-load signal



Distinctly audible and noticeable excess-load signal when the pre-set torque is reached.

16-piece set

Folding pouch with one 7515 torque screwdriver with easy quick torque setting and 15 tough bits (89 mm length)

05075851001	
7515	1x 1/4"x2,0 Nm; 3,0 Nm; 4,0 Nm; 5,0 Nm; 6,0 Nm x147,5
+	851/4 Z 1x PH 2x89
⊕	867/4 Z 1x TX 10x89; 1x TX 15x89; 1x TX 20x89; TORX® BO 1x TX 25x89; 1x TX 30x89
⊕	867/4 IP TORX PLUS® 1x 10 IPx89; 1x 15 IPx89; 1x 20 IPx89; 1x 25 IPx89; 1x 30 IPx89
○	840/4 Z 1x 3,0x89; 1x 4,0x89; 1x 5,0x89; 1x 6,0x89 ¹⁾

¹⁾ Hexagonal blade

New solution for setting the torque correctly



→ www.wera.de/torque-advisor

For right and left direction

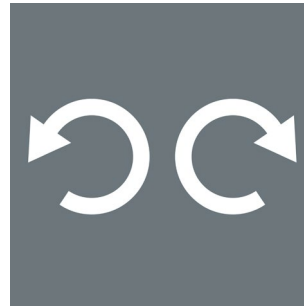

The Click-Torque wrenches for insert tools are suitable for clockwise and counterclockwise uses.

9530 Torque wrench set for heat pumps/air conditioning



4-piece set; in surface-friendly, compact and extremely robust textile box. Small size and low weight for better mobility.

One Click-Torque X 7 torque wrench with 14x18 mm mounting for insert tools, measuring range 10-100 Nm, accuracy $\pm 4\%$ of the set value, as per DIN EN ISO 6789-1:2017-07, for clockwise and anti-clockwise torque-control; easy setting and saving of the required torque, with audible and tactile locking when the scale values are reached (fine scale only in Newton meters), audible and tactile release mechanism when the set torque value is reached, ergonomic 2-component handle, 3 self-setting Joker 7880 exchangeable insert spanners with ratchet functionality.

05136076001	Click-Torque X 7	1x 14x18, 10-100 Nm
	7880 Joker XXL	1x 14x18x24-32 ($5/16''-1 1/4''$)x113,5
	7880 Joker XL	1x 14x18x19-24 ($3/4''-15/16''$)x95,0
	7880 Joker L	1x 14x18x16-19 ($5/8''-3/4''$)x85,5

For air conditioning lines



With the 9530 set, the screw connections used for refrigeration and air conditioning systems as well as heat pump lines can be properly tightened.

Click-Torque X 7 torque wrench



Measuring range 10-100Nm; with mounting for exchangeable insert tools 14x18 mm.

Click-Torque X 7 torque wrench for insert tools, 10-100 Nm

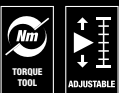

Application: For clockwise and anti-clockwise torque-control

Precision: Accuracy $\pm 4\%$ of the set value, as per DIN EN ISO 6789-1:2017-07

Design: With mounting for exchangeable insert tools 14x18 mm; easy setting and saving of the required torque, with audible and tactile locking when the scale values are reached (fine scale only in Newton meters), audible and tactile release mechanism when the set torque value is reached

Handle: Ergonomic 2-component handle

		Nm	Nm	lbf. ft.	mm	S _k	l _k									
05075657001	14x18	10-100	0,5	8-73	395	25,5	343,0	140	47	29	20	14 4/64"	5 33/64"	1 27/32"	1 9/64"	25/32"

¹ S_k = Actual dimension of the test attachment; l_k = Distance from the force application point to the test device axis

7880 Joker XXL Self-setting insert spanner for wrench sizes 24-32 mm, 14x18mm

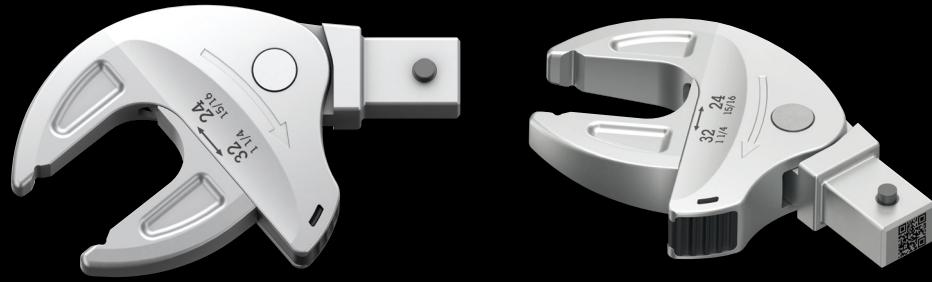

Application: Hexagonal screw heads and bolts
Drive: 14x18 mm; for torque wrenches of the Click-Torque X and XP series with 14x18 mm mounting
Design: Self-setting spanner with ratchet functionality; open end adjustable in size, parallel smooth jaws; with 30° return angle via the corner-width prisms in the jaw

	mm	mm	mm	mm			mm	mm
05020173001	14x18	24-32	24,0	62,2	15/16"-1 1/4"	15/16"	62,2	113,5
			27,0	68,0		3/32"	63,9	
			30,0	70,2		1"	65,4	
			32,0	70,4		1 1/16"	66,4	
						1 1/8"	69,5	
						1 3/16"	70,1	
			1 1/4"	70,2				

7880 Joker XL Self-setting insert spanner for wrench sizes 19-24 mm, 14x18mm

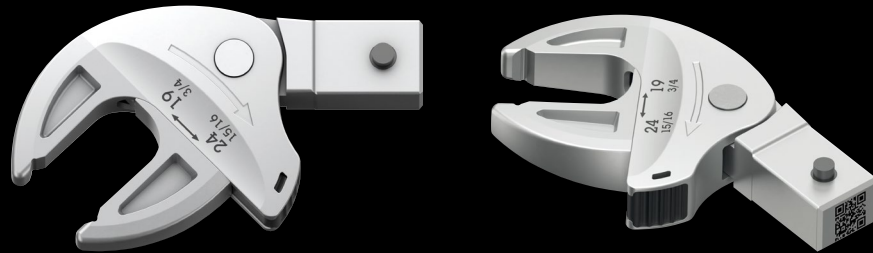

Application: Hexagonal screw heads and bolts
Drive: 14x18 mm; for torque wrenches of the Click-Torque X and XP series with 14x18 mm mounting
Design: Self-setting spanner with ratchet functionality; open end adjustable in size, parallel smooth jaws; with 30° return angle via the corner-width prisms in the jaw

	mm	mm	mm	mm			mm	mm
05020172001	14x18	19-24	19,0	51,6	3/4"-15/16"	3/4"	51,6	95,0
			20,0	53,6		25/32"	53,3	
			21,0	55,4		13/16"	54,7	
			22,0	56,7		7/8"	56,7	
			24,0	56,7		15/16"	56,7	

7880 Joker L Self-setting insert spanner for wrench sizes 16-19 mm, 14x18mm

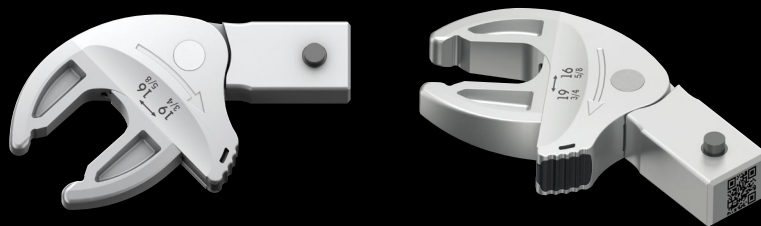

Application: Hexagonal screw heads and bolts
Drive: 14x18 mm; for torque wrenches of the Click-Torque X and XP series with 14x18 mm mounting
Design: Self-setting spanner with ratchet functionality; open end adjustable in size, parallel smooth jaws; with 30° return angle via the corner-width prisms in the jaw

	mm	mm	mm	mm			mm	mm
05020171001	14x18	16-19	16,0	44,6	5/8"-3/4"	5/8"	44,4	85,5
			17,0	46,7		11/16"	47,3	
			18,0	48,2		3/4"	49,1	
			19,0	49,1				

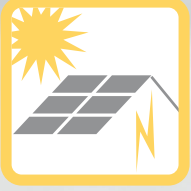

9524 Photovoltaic mounting tool set 1



7-piece tool set for installing photovoltaic systems. One 7442 adjustable torque screwdriver (pistol handle) for the measuring range 3.0-6.0 Nm. One 889/4/1 F Rapidaptor bitholder with fast-rotating function for a particularly quick return movement without having to remove the tool during clockwise torque operation. One 6003 Joker ring spanner. 2 installation tools for MC4 solar connectors (Multi-Contact). One socket 1/2" (with side wire cutout) size 17 for installing panel connectors. One tool shaft (adapter 1/4" to 1/2") for manually operated square head sockets.

05136043001		
●	7400 pistol grip	1x 7442, 3,0-6,0 Nm
●	8790 HMC Deep with cutout	1x 17,0x76,0
○ ○	870/4 A	1x 1/4"x1/2"x72
● ○	889/4/1 F	1x 1/4"x64
	6003 Joker	1x 17x190
	9108	2x 115
	Hook and Loop Fastener Strip 120	1x 50,0x120,0

For installing solar systems



The set includes the screwdriving tools required for installing solar systems such as torque wrenches, ring spanners and installation tools for solar connectors.

889/4/1 F Rapidaptor free-running bit holder



Especially for applications with Wera torque screwdrivers with pistol handle for fast and ergonomic working.

Installation tool for MC4 solar connectors

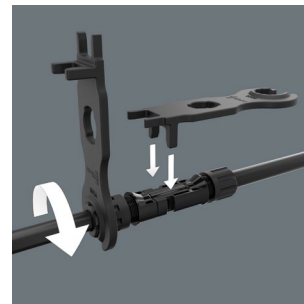

























For tightening and loosening the cable connection and to release the locking of the plug connection.

Socket with side wire cutout



Particularly suitable for mounting temperature sensors, thermo switches and other components that are cabled from the top and sides.

Which type of bit is needed for which job?

		 TAKE IT EASY TOOL FINDER	 TORSION	 BITORSION	 DIAMOND	 IMPACT PROOF	 REDUCED DIAMETER	 EDELSTAHL® Rost frei INOX STAINLESS	 HOLDING FUNCTION	
 ★★★★	Z									universal
 ★★★★★	TZ		●							tough / metal applications
 ★★★★★	BTZ	●		●						extra tough / metal applications
 ★★★★★	TH		●							hard / wood applications
 ★★★★★	BTH	●		●						extra hard / wood applications
 ★★★★★	BDC	●		●	●					extra hard and diamond- coated / improves hold in the screw
 ★★★★★	IMP DC	●		●	●	●				suitable for the use of an impact machine
 ★★★★★	TS	●	●					●		prevents flash rust / stainless steel / offshore / water sports / food
 ★★★★★	TORX® HF	●							●	holding function due to special profile / can also be used for ASSY and SPAX T-STAR
 ★★★★	RZ						●			reduced shank / tough / universal
 ★★★★	RH						●			reduced shaft / hard / universal
 ★★★★	RDC				●		●			reduced shank / diamond-coated / drywall
 ★★★★	J(CIS)									Japanese Industrial Stan- dard, for Asian PH screws
 ★★★★★	TZ ACR		●							reduced slipping out of the screw thanks to Anti Cam- Out Ribs, universal
 ★★★★★	A									hard / aviation
 ★★★★★	AH									extra hard / aviation
 ★★★★★	ADC				●					extra hard / diamond coated / aviation

Bit Holders

897/4 IMP R Impaktor holder with retaining ring and ring magnet



Wera Impaktor holder for the absorption of impulse peaks. Particular torsion effect thanks to the double-torsion spring. The Impaktor holder additionally holds long and heavy screws extremely securely with its ring magnet. This enables rapid and dependable positioning of the screw.

897/4 R Rapidaptor BiTorsion Universal Bit Holder



Designed with special BiTorsion zone. The energy from peak loads is diverted into the BiTorsion zone. Considerable reduction of the risk of breakage, much longer service life.

887/4 RR Rapidaptor Universal Bit Holder with ring magnet



The floating, free-turning magnetic sleeve securely holds even large and heavy screws to enable immediate application. There is no need to hold the screw when applying the tool – something which can be dangerous and painful. Also ideal for overhead work.

889/4/1 K Rapidaptor Universal Bit Holder



Rapid bit change without needing any additional tools. One-hand operation with a freely spinning sleeve for simplified guidance of the tool.

894/4/1 K Universal Bit Holder

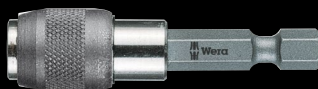

For a firm, wobble-free connection between holder and bit with quick-release action. Simply push sleeve forward to change bits. The non-magnetic version prevents any unwanted attraction of metal filings.

893/4/1 K Universal Bit Holder



With stainless steel sleeve and strong permanent magnet.

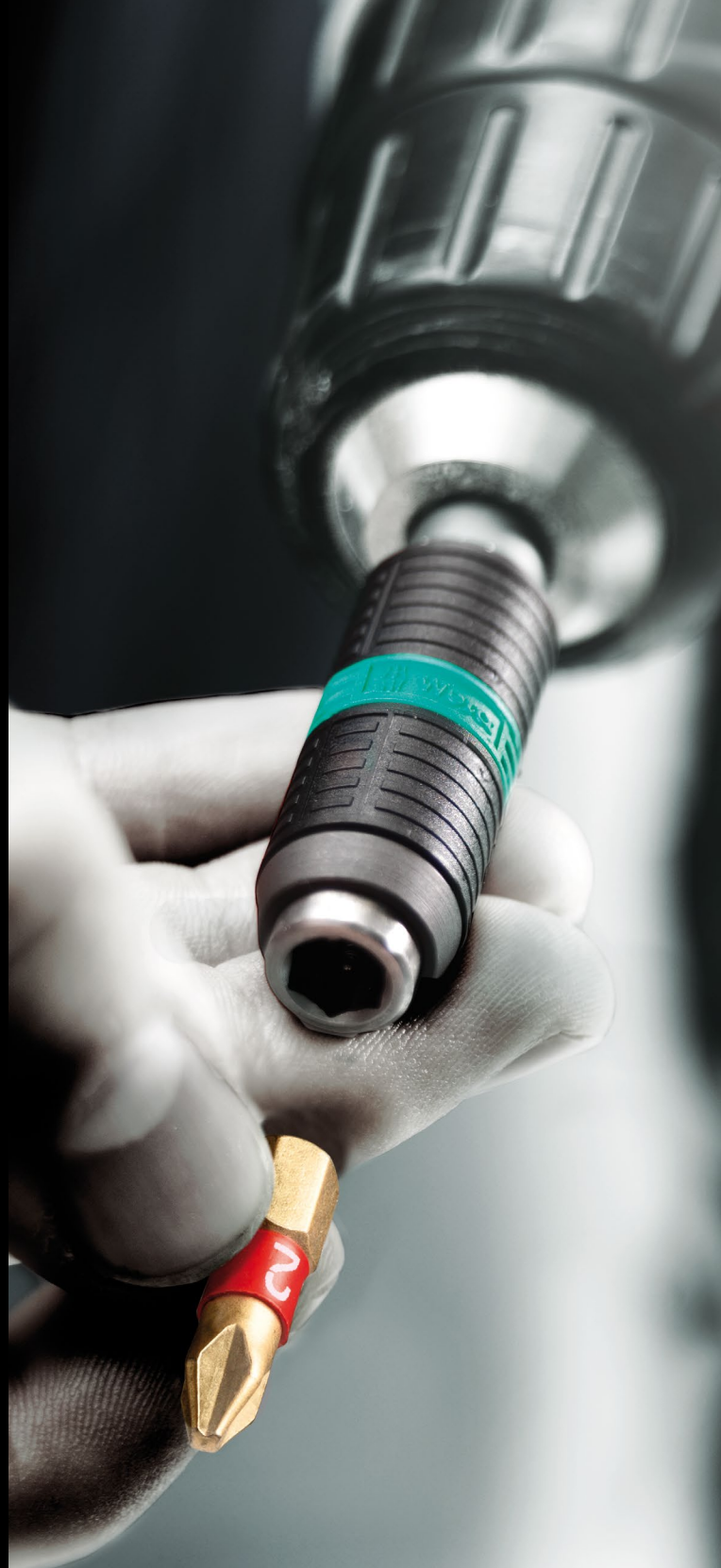

Bit-Check 30 Wood TX HF 1



One Rapidaptor universal holder with ring magnet and quick-release chuck, 29 bits, 867/1 TORX® HF with holding function for TORX® socket screws as per the specification Acument Intellectual Properties, also suitable for Würth ASSY screws as well as Altenloh SPAX T-STAR plus screws, with "Take it easy" tool finder: colour coding by size. TZ bits with torsion shape against premature wear, tough, for universal use; TH bits with torsion shape against premature wear, extra-hard

05057436001	
●●	887/4 RR 1x 1/4"x57
+	851/1 TZ 2x PH 2x25; 1x PH 3x25
+	855/1 TH 3x PZ 1x25; 6x PZ 2x25; 2x PZ 3x25
⊕	867/1 TORX® HF 2x TX 10x25; 2x TX 15x25; 4x TX 20x25; 4x TX 25x25; 2x TX 30x25; 1x TX 40x25 ¹⁾

¹⁾ Pound-thru hexagonal; no Take it easy.

Bit-Check 30 Universal 1



1 bit holder Rapidaptor with quick-release chuck, 29 bits, Torsion-style (T) design to reduce premature wear, tough (Z), for universal use, extra-hard (H).

05056440001	
●●	889/4/1 K 1x 1/4"x50
+	851/1 TZ 2x PH 1x25; 3x PH 2x25; 1x PH 3x25
+	855/1 TH 2x PZ 1x25; 3x PZ 2x25; 1x PZ 3x25
⊕	867/1 TZ TORX® 1x TX 10x25; 1x TX 15x25; 1x TX 20x25; 1x TX 25x25; 1x TX 30x25; 1x TX 40x25
⊕	867/1 Z TORX® BO 1x TX 10x25; 1x TX 15x25; 1x TX 20x25; 1x TX 25x25; 1x TX 30x25
⊖	800/1 TZ 1x 1,0x5,5x25
○	840/1 Z 1x 3,0x25; 1x 4,0x25; 1x 5,0x25; 1x 6,0x25; 1x 8,0x25



Holding function for recessed TORX® screws



The HF tools developed by Wera are ideal because they feature an optimised geometry of the original TORX® profile. The wedging forces resulting from the surface pressure between the drive tip and the screw profile mean that TORX® screws made according to Acument Intellectual Properties specifications are securely held on the tool!

Also for ASSY and SPAX T-STAR plus screws



The Wera 867/1 TX HF bits are also suitable for Würth ASSY screws as well as Altenloh SPAX T-STAR plus screws.



Rapidaptor with ringmagnet



The floating, free-turning magnetic sleeve securely holds even large and heavy screws to enable immediate application. There is no need to hold the screw when applying the tool – something which can be dangerous and painful. Also ideal for overhead work.

Bit-Check 12 BiTorsion 1



1 bit holder Rapidaptor with quick-release chuck, 11 BiTorsion bits for long service life, tough, for universal use. The "Take it easy" Bit-Checks have bits with a sleeve which – from its colour and size designation – make it simple to access the right bit quickly.

05057420001			
⊙ ⊙	889/4/1 K	1x 1/4"x50	
+	851/1 BTZ	1x PH 1x25; 2x PH 2x25	
+	855/1 BTZ	1x PZ 1x25; 2x PZ 2x25	
⊕	867/1 TORX® BTZ	1x TX 10x25; 1x TX 15x25; 1x TX 20x25; 1x TX 25x25; 1x TX 30x25	

Bit-Check 7 Diamond 1

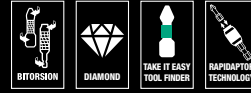

1 bit holder Rapidaptor with quick-release chuck, 6 BiTorsion bits for long service life, diamond-coated (BDC) for secure screw fit. The "Take it easy" Bit-Checks have bits with a sleeve which – from its colour and size designation – make it simple to access the right bit quickly.

05057416001			
⊙ ⊙	889/4/1 K	1x 1/4"x50	
+	851/1 BDC	1x PH 1x25; 1x PH 2x25	
+	855/1 BDC	1x PZ 1x25; 1x PZ 2x25	
⊖	800/1 BDC	1x 1,0x5,5x25; 1x 1,2x6,5x25	

Bit-Check 10 Impaktor 1

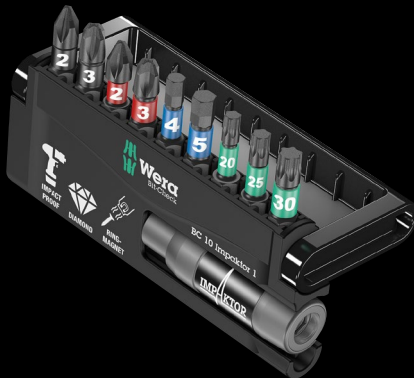
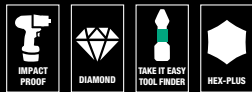

1 Impaktor holder with retaining ring and ring magnet in the chuck for a secure fit of the bits in the holder, 9 Impaktor bits. The "Take it easy" Bit-Checks have bits with a sleeve which – from its colour and size designation – make it simple to access the right bit quickly.

05057680001			
⊙ ⊙	897/4 Impaktor R	1x 1/4"x75	
+	851/1 Impaktor DC	1x PH 2x25; 1x PH 3x25	
+	855/1 Impaktor DC	1x PZ 2x25; 1x PZ 3x25	
⊕	867/1 TORX® Impaktor DC	1x TX 20x25; 1x TX 25x25; 1x TX 30x25	
⊙	840/1 Impaktor DC	1x 4,0x25; 1x 5,0x25	



Bits with diamond coating

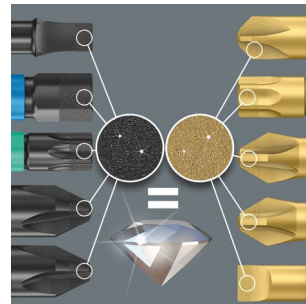

The diamond coating of the DC bits lowers the danger of slipping as the minute diamond particles literally "bite" themselves into the screw head.



Impaktor Bits



Impaktor bits are needed when a strong power tool is used. Impaktor bits were specifically developed to withstand high power tool forces.

Roller cabinet and foam inserts







Exclusive roller cabinet in the Tool Rebel design. Five flat and two high drawers ensure efficient, mobile organization of tools and materials. Extremely robust design thanks to a double-walled design and the completely welded construction of the entire body. For daily hard work in the workshop. Equipped with four Wera foam inserts: 9710 foam insert screwdriver set 1, 9720 foam insert 8000 A Zyklop ratchet set 1, 9731 foam insert 6003 Joker ring spanner set 1, 9740 foam insert L-key set 1.

Highly manoeuvrable

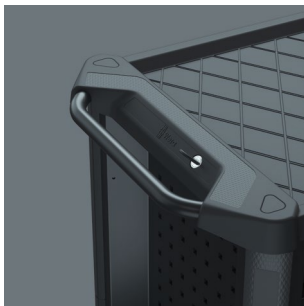

The ergonomically designed handlebar ensures that the roller cabinet is highly manoeuvrable. Durable handle thanks to the black powder-coated metal design.

Sophisticated drawer design



The drawers are equipped with ball bearing telescopic slides and can be pulled out completely. Self-closing and mutually locking to prevent unintentional opening, thus minimal risk of tilting for roller cabinets. The carefully considered drawer design allows optimal use of the interior space. The dirt-resistant drawer coating makes cleaning easy.

05150130001 1x 9700	
1x 9710	
⊖ 932 A	1x 1.0x5.5x100; 1x 1.2x7.0x125
⊕ 350 PH	1x PH 1x80; 1x PH 2x100; 1x PH 3x150
⊕ 350 PH Stubby/carburetor screwdriver	1x PH 2x25
⊕ 355 PZ	1x PZ 1x80; 1x PZ 2x100
⊖ 335	1x 0.8x4.0x100; 1x 1.0x5.5x125
⊖ 334	1x 1.2x6.5x150
⊖ 335 Stubby/carburetor screwdriver	1x 1.0x5.5x24.5
⊕ 2050 Micro	1x PH 0x40
⊖ 2035 Micro	1x 0.40x2.5x80
⊖ 160 i VDE	1x 0.4x2.5x80; 1x 0.6x3.5x100
1441	1x 4.5-6.0x41.0
1442	1x 6.0-8.5x41.0
9810	1x 344,0x30,0x392,0
1x 9720	
○ 8000 A	1x 1/4"x152.0
⊗ 8794 LA	1x 1/4"x150.0
⊗ 8794 SA	1x 1/4"x75.0
⊗ 8795 A	1x 1/4"x35.5
⊗ 8794 A	1x 1/4"x56.0
⊗ 8790 HMA	1x 4.0x23.0; 1x 4.5x23.0; 1x 5.0x23.0; 1x 5.5x23.0; 1x 6.0x23.0; 1x 7.0x23.0; 1x 8.0x23.0; 1x 9.0x23.0; 1x 10.0x23.0; 1x 11.0x23.0; 1x 12.0x23.0; 1x 13.0x23.0; 1x 14.0x23.0; 1x 15.0x23.0
⊗ 8767 A HF	1x TX 8x28,0; 1x TX 9x28,0; 1x TX 10x28,0; 1x TX 15x28,0; 1x TX 20x28,0; 1x TX 25x28,0; 1x TX 27x28,0; 1x TX 30x28,0; 1x TX 40x28,0
○ 8740 A HF	1x 3.0x28,0; 1x 4.0x28,0; 1x 4.0x100,0; 1x 5.0x28,0; 1x 5.0x100,0; 1x 6.0x28,0; 1x 6.0x100,0; 1x 8.0x28,0; 1x 8.0x100,0
9820	1x 172,0x30,0x392,0
1x 9731	
6003 Joker	1x 6x105; 1x 7x110; 1x 8x115; 1x 9x120; 1x 10x125; 1x 11x135; 1x 12x148; 1x 13x160; 1x 14x167; 1x 15x174; 1x 16x182; 1x 17x190; 1x 18x210; 1x 19x230,0; 1x 20x230,0; 1x 21x260; 1x 22x260; 1x 24x280
Bottle opener	1x 148
9831	1x 344,0x30,0x392,0
1x 9740	
1x 950/9 Hex-Plus Multicolour 1	
○ 950 SPKL Multicolour	1x 1.5x90; 1x 2.0x101; 1x 2.5x112; 1x 3.0x123; 1x 4.0x137; 1x 5.0x154; 1x 6.0x172; 1x 8.0x195; 1x 10.0x224
1x 967/9 TX XL Multicolour 1	
⊗ 967 SXL TORX® Multicolour	1x TX 8x90; 1x TX 9x101; 1x TX 10x112
⊗ 967 SPKXL TORX® Multicolour	1x TX 15x123; 1x TX 20x137; 1x TX 25x154; 1x TX 27x172; 1x TX 30x195; 1x TX 40x224
1x 9500	
	1x 64,6
1x STABILA® BM 100 Pocket tape, metric scale, 3 m, item 19570	
	1x 3000,0
1x 9840	
	1x 172,0x30,0x392,0

9710 Foam insert screwdriver set 1



18-piece tool set (16 screwdrivers, 2 screw grippers) in a two-coloured foam insert for the Tool Rebel roller cabinet. Width x height x depth: without tools 344 x 30 x 392 mm, with tools 344 x 47 x 392 mm.

05150101001		
⊖	932 A	1x 1,0x5,5x100; 1x 1,2x7,0x125
⊕	350 PH	1x PH 1x80; 1x PH 2x100; 1x PH 3x150
⊕	350 PH Stubby/carburetor screwdriver	1x PH 2x25
⊕	355 PZ	1x PZ 1x80; 1x PZ 2x100
⊖	335	1x 0,8x4,0x100; 1x 1,0x5,5x125
⊖	334	1x 1,2x6,5x150
⊖	335 Stubby/carburetor screwdriver	1x 1,0x5,5x24,5
⊕	2050 Micro	1x PH 0x40 ¹⁾
⊖	2035 Micro	1x 0,40x2,5x80
⊖	160 i VDE	1x 0,4x2,5x80 ²⁾ ; 1x 0,6x3,5x100 ³⁾
	1441	1x 4,5-6,0x41,0
	1442	1x 6,0-8,5x41,0
	9810	1x 344,0x30,0x392,0 ³⁾

¹⁾ Size 0 modified according to JCS 0 (Japanese Camera Industrial Standard)

²⁾ without Lasertip

³⁾ Attention: The foam insert does not fit in the previous model 05501051001 of the roller cabinet.

9711 Foam insert VDE screwdriver set 1

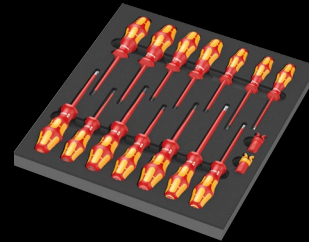

16-piece VDE-insulated screwdriver set (14 screwdrivers, 2 screw grippers) in a two-coloured foam insert for the Tool Rebel roller cabinet. Width x height x depth: without tools 344 x 30 x 392 mm, with tools 344 x 46 x 392 mm.

05150102001		
⊕	162 iS PH VDE	1x PH 1x80; 1x PH 2x100
⊕	165 iS PZ VDE	1x PZ 1x80; 1x PZ 2x100
⊕	165 i PZ/S VDE	1x # 2x100
⊖	160 i VDE	1x 0,4x2,5x80 ¹⁾ ; 1x 0,8x4,0x100; 1x 1,0x5,5x125
⊖	160 iS VDE	1x 0,6x3,5x100
⊕	167 i TORX® VDE	1x TX 10x80; 1x TX 15x80; 1x TX 20x80; 1x TX 25x100; 1x TX 30x100
	1440	1x 4,5-6,0x41,0
	1442	1x 6,0-8,5x41,0
	9811	1x 344,0x30,0x392,0 ²⁾

¹⁾ without Lasertip

²⁾ Attention: The foam insert does not fit in the previous model 05501051001 of the roller cabinet.

9712 Foam insert TORX® HF screwdriver set 1

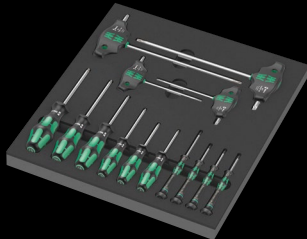

14-piece screwdriver set with holding function for TORX® screws in a two-coloured foam insert for the Tool Rebel roller cabinet. Width x height x depth (without tools): 344 x 30 x 392 mm, with tools 344 x 45 x 392 mm.

05150103001		
⊕	367 TORX® HF	1x TX 8x60; 1x TX 9x60; 1x TX 10x80; 1x TX 15x80; 1x TX 20x100; 1x TX 25x100
⊕	2067 TORX® HF	1x TX 4x40; 1x TX 5x40; 1x TX 6x40; 1x TX 7x60
⊕	467 TORX® HF	1x TX 20x100; 1x TX 25x100; 1x TX 30x200; 1x TX 40x200
	9812	1x 344,0x30,0x392,0 ¹⁾

¹⁾ Attention: The foam insert does not fit in the previous model 05501051001 of the roller cabinet.

9713 Foam insert Hex screwdriver set 1

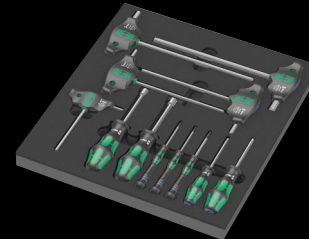

12-piece screwdriver set for hexagonal socket screws and external hexagon screws in a two-coloured foam insert for the Tool Rebel roller cabinet. Width x height x depth (without tools): 344 x 30 x 392 mm, with tools 344 x 45 x 392 mm.

05150104001		
○	354	1x 3,0x75; 1x 4,0x75
○	2054 Micro	1x 1,5x60; 1x 2x60; 1x 2,5x60
○	454 HF	1x 4x100; 1x 5x100; 1x 6x150; 1x 8x200; 1x 10x200
●	395 H0	1x 10,0x90; 1x 13,0x90
	9813	1x 344,0x30,0x392,0 ¹⁾

¹⁾ Attention: The foam insert does not fit in the previous model 05501051001 of the roller cabinet.

9720 Foam insert 8000 A Zyklop 1/4" ratchet set 1

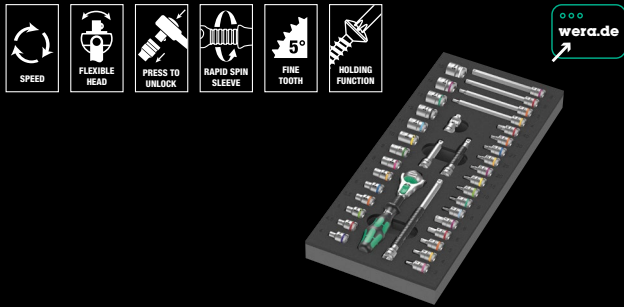

37-piece Zyklop ratchet set, 1/4", in a two-coloured foam insert for the Tool Rebel roller cabinet. Width x height x depth: without tools 172 x 30 x 392 mm, with tools 172 x 40 x 392 mm.

05150110001		
○	8000 A	1x 1/4"x152,0
●○	8794 LA	1x 1/4"x150,0
●○	8794 SA	1x 1/4"x75,0
●○	8795 A	1x 1/4"x35,5
●○	8794 A	1x 1/4"x56,0
●	8790 HMA	1x 4,0x23,0; 1x 4,5x23,0; 1x 5,0x23,0; 1x 5,5x23,0; 1x 6,0x23,0; 1x 7,0x23,0; 1x 8,0x23,0; 1x 9,0x23,0; 1x 10,0x23,0; 1x 11,0x23,0; 1x 12,0x23,0; 1x 13,0x23,0; 1x 14,0x23,0; 1x 15,0x23,0
⊕	8767 A HF	1x TX 8x28,0; 1x TX 9x28,0; 1x TX 10x28,0; 1x TX 15x28,0; 1x TX 20x28,0; 1x TX 25x28,0; 1x TX 27x28,0; 1x TX 30x28,0; 1x TX 40x28,0
○	8740 A HF	1x 3,0x28,0; 1x 4,0x28,0; 1x 4,0x100,0; 1x 5,0x28,0; 1x 5,0x100,0; 1x 6,0x28,0; 1x 6,0x100,0; 1x 8,0x28,0; 1x 8,0x100,0
	9820	1x 172,0x30,0x392,0 ¹⁾

¹⁾ Attention: The foam insert does not fit in the previous model 05501051001 of the roller cabinet.

9721 Foam insert 8000 B Zyklop 3/8" ratchet set 1

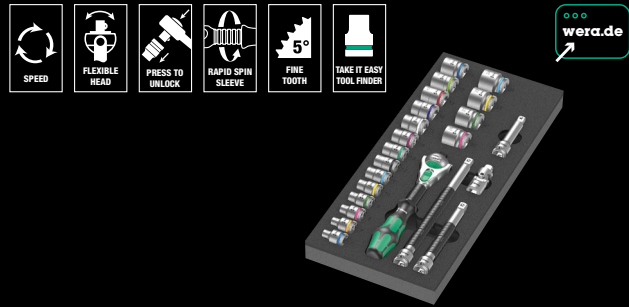

23-piece Zyklop ratchet set, 3/8", in a two-coloured foam insert for the Tool Rebel roller cabinet. Width x height x depth: without tools 172 x 30 x 392 mm, with tools 172 x 45 x 392 mm.

05150111001		
○	8000 B	1x 3/8"x199,0
●○	8794 SB	1x 3/8"x125,0
●○	8794 LB	1x 3/8"x200,0
●○	8795 B	1x 3/8"x50,0
●○	8794 B	1x 3/8"x76,0
●	8790 HMB	1x 6,0x29,0; 1x 7,0x29,0; 1x 8,0x29,0; 1x 9,0x29,0; 1x 10,0x29,0; 1x 11,0x29,0; 1x 12,0x29,0; 1x 13,0x29,0; 1x 14,0x29,0; 1x 15,0x29,0; 1x 16,0x30,0; 1x 17,0x30,0; 1x 18,0x30,0; 1x 19,0x30,0; 1x 20,0x30,0; 1x 21,0x30,0; 1x 22,0x30,0; 1x 24,0x32,0
	9821	1x 172,0x30,0x392,0 ¹⁾

¹⁾ Attention: The foam insert does not fit in the previous model 05501051001 of the roller cabinet.

9722 Foam insert 8000 C Zyklop 1/2" ratchet set 1



31-piece set Zyklop ratchet set, 1/2", in a two-coloured foam insert for the Tool Rebel roller cabinet. Width x height x depth: without tools 344 x 30 x 392 mm, with tools 344 x 51 x 392 mm.

05150112001		
○	8000 C	1x 1/2"x277,0
●○	8794 LC	1x 1/2"x250,0
●○	8794 SC	1x 1/2"x125,0
●○	8795 C	1x 1/2"x69,0
●○	8794 C	1x 1/2"x52,0
●	8790 HMC	1x 10,0x37,0; 1x 11,0x37,0; 1x 12,0x37,0; 1x 13,0x37,0; 1x 14,0x37,0; 1x 15,0x37,0; 1x 16,0x37,0; 1x 17,0x37,0; 1x 18,0x37,0; 1x 19,0x37,0; 1x 20,0x37,0; 1x 21,0x37,0; 1x 22,0x37,0; 1x 24,0x37,0; 1x 27,0x40,0; 1x 30,0x42,0; 1x 32,0x42,0
○	8740 C HF	1x 4,0x60,0; 1x 4,0x140,0; 1x 5,0x60,0; 1x 5,0x140,0; 1x 6,0x60,0; 1x 6,0x140,0; 1x 7,0x60,0; 1x 8,0x60,0; 1x 10,0x60,0
	9822	1x 344,0x30,0x392,0 ¹⁾

¹⁾ Attention: The foam insert does not fit in the previous model 05501051001 of the roller cabinet.

9723 Foam insert Zyklop B 3/8" bit socket set 1



22-piece Zyklop bit socket set, 3/8", in a two-coloured foam insert for the Tool Rebel roller cabinet. Width x height x depth: without tools 172 x 30 x 392 mm, with tools 172 x 39 x 392 mm.

05150113001		
●○	8784 B1	1x 1/4"x3/8"x44,0
⊕	8767 B HF	1x TX 15x35,0; 1x TX 20x35,0; 1x TX 25x35,0; 1x TX 25x107,0; 1x TX 27x35,0; 1x TX 27x107,0; 1x TX 30x35,0; 1x TX 30x107,0; 1x TX 40x35,0; 1x TX 40x107,0
○	8740 B HF	1x 4,0x35,0; 1x 4,0x107,0; 1x 5,0x35,0; 1x 5,0x107,0; 1x 6,0x35,0; 1x 6,0x107,0; 1x 7,0x38,5; 1x 8,0x38,5; 1x 8,0x100,0; 1x 10,0x38,5; 1x 10,0x100,0
	9823	1x 172,0x30,0x392,0 ¹⁾

¹⁾ Attention: The foam insert does not fit in the previous model 05501051001 of the roller cabinet.

9730 Foam insert 6000 Joker set 1

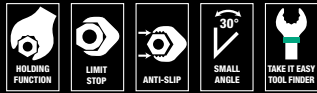

11-piece 6000 Joker ring ratchet spanner set, in a two-coloured foam insert for the Tool Rebel roller cabinet. Width x height x depth: without tools 172 x 30 x 392 mm, with tools 172 x 47 x 392 mm.

05150120001		
6000 Joker	1x 8x144; 1x 10x159; 1x 11x165; 1x 12x170,7; 1x 13x177; 1x 14x188; 1x 15x200; 1x 16x212; 1x 17x224; 1x 18x235; 1x 19x246	
9830	1x 172,0x30,0x392,0 ¹⁾	

¹⁾ Attention: The foam insert does not fit in the previous model 05501051001 of the roller cabinet.

9732 Foam insert 6004 Joker set 1



5-piece 6004 Joker self-setting spanner set, in a two-coloured foam insert for the Tool Rebel roller cabinet. Width x height x depth: without tools 172 x 30 x 392 mm, with tools 172 x 35 x 392 mm.

05150122001		
6004 Joker XS	1x 7-10 (1/4"-3/8")x117	
6004 Joker S	1x 10-13 (7/16"-1/2")x154	
6004 Joker M	1x 13-16 (1/2"-5/8")x188	
6004 Joker L	1x 16-19 (9/16"-3/4")x224	
6004 Joker XL	1x 19-24 (3/4"-19/16")x256	
9832	1x 172,0x30,0x392,0 ¹⁾	

¹⁾ Attention: The foam insert does not fit in the previous model 05501051001 of the roller cabinet.

9731 Foam insert 6003 Joker set 1

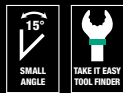

9740 Foam insert L-key set 1

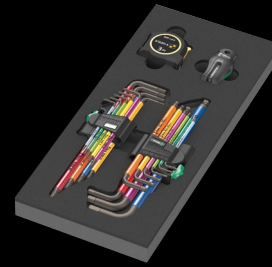

18-piece L-key set (hexagonal socket screws and TORX® screws) plus one Wera magnet and one Stabila pocket tape measure (3 m), in a two-coloured foam insert for the Tool Rebel roller cabinet. Width x height x depth: without tools 172 x 30 x 392 mm, with tools 172 x 44 x 392 mm.

05150140001		
1x 950/9 Hex-Plus Multicolour 1		
950 SPKL Multicolour	1x 1.5x90; 1x 2.0x101; 1x 2.5x112; 1x 3.0x123; 1x 4.0x137; 1x 5.0x154; 1x 6.0x172; 1x 8.0x195; 1x 10.0x224	
1x 967/9 TX XL Multicolour 1		
967 SXL TORX® Multicolour	1x TX 8x90; 1x TX 9x101; 1x TX 10x112	
967 SPKXL TORX® Multicolour	1x TX 15x123; 1x TX 20x137; 1x TX 25x154; 1x TX 27x172; 1x TX 30x195; 1x TX 40x224	
1x 9500		
	1x 64,6	
1x STABILA® BM 100 Pocket tape, metric scale, 3 m, item 19570		
	1x 3000,0	
1x 9840		
	1x 172,0x30,0x392,0 ¹⁾	

¹⁾ Attention: The foam insert does not fit in the previous model 05501051001 of the roller cabinet.

18-piece 6003 Joker ring spanner set, 1 Kraftform bottle opener, in a two-coloured foam insert for the Tool Rebel roller cabinet. Width x height x depth: without tools 344 x 30 x 392 mm, with tools 344 x 58 x 392 mm.

05150121001		
6003 Joker	1x 6x105; 1x 7x110; 1x 8x115; 1x 9x120; 1x 10x125; 1x 11x135; 1x 12x148; 1x 13x160; 1x 14x167; 1x 15x174; 1x 16x182; 1x 17x190; 1x 18x210; 1x 19x230,0; 1x 20x230,0; 1x 21x260; 1x 22x260; 1x 24x280	
Bottle opener	1x 148	
9831	1x 344,0x30,0x392,0 ¹⁾	

¹⁾ Attention: The foam insert does not fit in the previous model 05501051001 of the roller cabinet.

9780 Foam insert KNIPEX pliers set 1



3-piece pliers set (1x KNIPEX combination pliers, chrome-plated, 1x KNIPEX Cobra® high-tech water pump pliers, chrome-plated, 1x KNIPEX high leverage diagonal cutter, chrome-plated), in a two-coloured foam insert for the Tool Rebel roller cabinet. Width x height x depth: without tools 172 x 30 x 392 mm, with tools 172 x 38 x 392 mm.

05150180001	
KNIPEX Combination Pliers 03 05 180	1x 180
KNIPEX Cobra® High-Tech Water Pump Pliers 87 05 250	1x 250
KNIPEX High Leverage Diagonal Cutter 74 05 160	1x 160
9880	1x 172,0x30,0x392,0 ¹⁾

¹⁾ Attention: The foam insert does not fit in the previous model 05501051001 of the roller cabinet.

9781 Foam insert KNIPEX pliers set 2

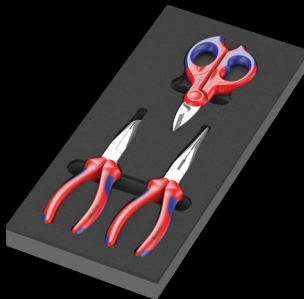

3-piece pliers set (1 KNIPEX snipe nose cutting pliers (stork beak pliers), 1 KNIPEX mechanics' pliers, 1 KNIPEX electricians' shears), in a two-coloured foam insert for the Tool Rebel roller cabinet. Width x height x depth: without tools 172 x 30 x 392 mm, with tools 172 x 38 x 392 mm.

05150181001	
KNIPEX Snipe Nose Cutting Pliers (Stork Beak Pliers) 26 15 200	1x 200
KNIPEX Mechanics' Pliers 38 25 200	1x 200
KNIPEX Electricians' Shears 95 05 155	1x 155
9881	1x 172,0x30,0x392,0 ¹⁾

¹⁾ Attention: The foam insert does not fit in the previous model 05501051001 of the roller cabinet.

9782 Foam insert hammer set 1



6-piece tool set (1 PICARD® riveting hammer (500 gr), 4 colour-coded RENN-STEIG parallel pin punches, 1 RENNSTEIG flat cold chisel), in a two-coloured foam insert for the Tool Rebel roller cabinet. Width x height x depth: without tools 172 x 30 x 392 mm, with tools 172 x 35 x 392 mm.

05150182001	
PICARD® riveting hammer 500 g, 0000101-500	1x 500,0
RENNSTEIG Parallel pin punches Exclusive	1x 452 003 6 RC, 3,0x150; 1x4520046RC,4,0x150;1x4520066RC,6,0x150; 1x 452 008 6 RC, 8,0x150
RENNSTEIG Flat cold chisel 310 250 1	1x 25,0x13,0x23,0
9882	1x 172,0x30,0x392,0 ¹⁾

¹⁾ Attention: The foam insert does not fit in the previous model 05501051001 of the roller cabinet.

9750 Foam insert Kraftform Kompakt and Tool-Check PLUS set 1



57-piece tool set (1 Tool-Check PLUS (39 pieces), 1 Kraftform Kompakt 60 (16 pieces) and one bitholding screwdriver with flexible shaft), in a two-coloured foam insert for the Tool Rebel roller cabinet. Width x height x depth: without tools 172 x 30 x 392 mm, with tools 172 x 59 x 392 mm.

05150150001	
1x Tool-Check PLUS	
● 8001 A	1x 1/4"x87.0
● 813	1x 1/4"x78
● 889/4/1 K	1x 1/4"x50
○ 870/1	1x 1/4"x25
● 8790 HMA	1x 5.5x23.0; 1x 6.0x23.0; 1x 7.0x23.0; 1x 8.0x23.0; 1x 10.0x23.0; 1x 12.0x23.0; 1x 13.0x23.0
⊕ 851/1 TZ	2x PH 1x25; 3x PH 2x25; 1x PH 3x25
⊕ 855/1 TH	1x PZ 1x25; 3x PZ 2x25; 1x PZ 3x25
⊕ 867/1 TZ TORX®	1x TX 10x25; 1x TX 15x25; 1x TX 20x25; 1x TX 25x25; 1x TX 30x25; 1x TX 40x25
⊕ 867/1 Z TORX® B0	1x TX 10x25; 1x TX 15x25; 1x TX 20x25; 1x TX 25x25; 1x TX 30x25
○ 840/1 Z	1x 3.0x25; 1x 4.0x25; 1x 5.0x25; 1x 6.0x25; 1x 8.0x25
⊖ 800/1 TZ	1x 1.0x5.5x25
1x Kraftform Kompakt 60	
● 816 R	1x 1/4"x119
⊕ 851/4 Z	1x PH 1x89; 1x PH 2x89; 1x PH 3x89
⊕ 855/4 Z	1x PZ 1x89; 1x PZ 2x89; 1x PZ 3x89
⊕ 867/4 Z TORX® B0	1x TX 10x89; 1x TX 15x89; 1x TX 20x89; 1x TX 25x89; 1x TX 30x89
⊖ 800/4 Z	1x 1.0x5.5x89
○ 840/4 Z	1x 3.0x89; 1x 4.0x89; 1x 5.0x89; 1x 6.0x89
Hook and Loop Fastener Strip 70	1x 50.0x70.0
1x 393 S	
●	1x 1/4"x173,5
1x 9850	
	1x 172,0x30,0x392,0 ¹⁾

¹⁾ Attention: The foam insert does not fit in the previous model 05501051001 of the roller cabinet.

9783 Foam insert PFERD file set 1

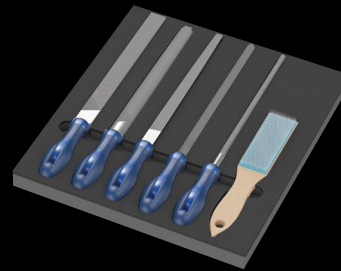

6-piece file set (1 PFERD file square PF1142 250 H2, 1 PFERD file half-round pointed PF 1152SP 250 H2, 1 PFERD file round PF1162 250 H2, 1 PFERD file hand PF-1112 250 H2, 1 PFERD file three square PF 1132 250 H2, 1 PFERD scratch brush HBF ST 0.15), in a two-coloured foam insert for the Tool Rebel roller cabinet. Width x height x depth: without tools 344 x 30 x 392 mm, with tools 344 x 42 x 392 mm.

05150183001	
PFERD machinist's file square PF1142 250 H2	1x 250
PFERD machinist's file half-round pointed 1152SP 250 H2	1x 250
PFERD machinist's file round 1162 250 H2	1x 250
PFERD machinist's file hand 1112 250 H2	1x 250
PFERD machinist's file three square 1132 250 H2	1x 250
PFERD scratch brush HBF steel wire Ø 0.15	1x 232
9883	1x 344,0x30,0x392,0 ¹⁾

¹⁾ Attention: The foam insert does not fit in the previous model 05501051001 of the roller cabinet.



Our competence

Wera is one of the world's leading manufacturers of screwdriving tools, with its corporate headquarters in Wuppertal/Germany. Wera develops and produces tools for professional, industrial applications, and is a solution-provider for problems associated with screw connections.

Tools created from ideas

Wera fascinates users time and again with quite exceptional product ideas. In practical applications these ideas – with their often unique features – result in a truly professional screwdriving performance.

Comprehensive range

The range comprises more than 3,000 products and includes genuine problem solvers, even for very specific jobs.

Quality manufacturer

The quality just has to be right. This is assured through a manufacturing process that is continually monitored, and as a result: the number of complaints is near zero. Of course, Wera is ISO-certified.

Brand and trademark rights

Wera is a manufacturer of branded goods and a reliable partner for the industry, trade and users. Numerous trademark rights, which are resolutely asserted worldwide, protect our customers against substandard imitations. Wera products are a guarantee for safe, reliable working and unbeatable performance.

Product design

Wera tools are stylish and ergonomic, and Wera has received several awards for the design of its products. To work with Wera tools is to understand what design really means.

Reliable logistics

Our ability to deliver any product from the catalogue range is almost 100 %. We naturally supply worldwide.

No liability for printing errors or mistakes shall be assumed.



Wera Werkzeuge GmbH
Korzterter Straße 21-25
D-42349 Wuppertal

Phone: +49 (0)202/4045-0
E-Mail: info@wera.de
www.wera.de

Wera Tools (UK) LTD.
Railway View
Clay Cross, Chesterfield
Derbyshire, S45 9FR

Phone: +44 (0)1246 / 277756
eMail: queries@weratools.co.uk
www.weratools.co.uk

Wera Tools Inc. (North America)
3325 Harvester Rd, Unit 16
Burlington, ON
L7N 3N2, Canada

Phone: 1-800-267-55 41
E-Mail: info@weratools.com
www.weratools.com

Wera Tools Australia Pty Ltd.
Phone: +61-435 755 123
E-Mail: mike.sack@wera.de

Wera Tools Japan G.K.
Phone: +81 70 4813 1142
E-Mail: frank.yang@wera.de

